

FOR INFORMATION ONLY !

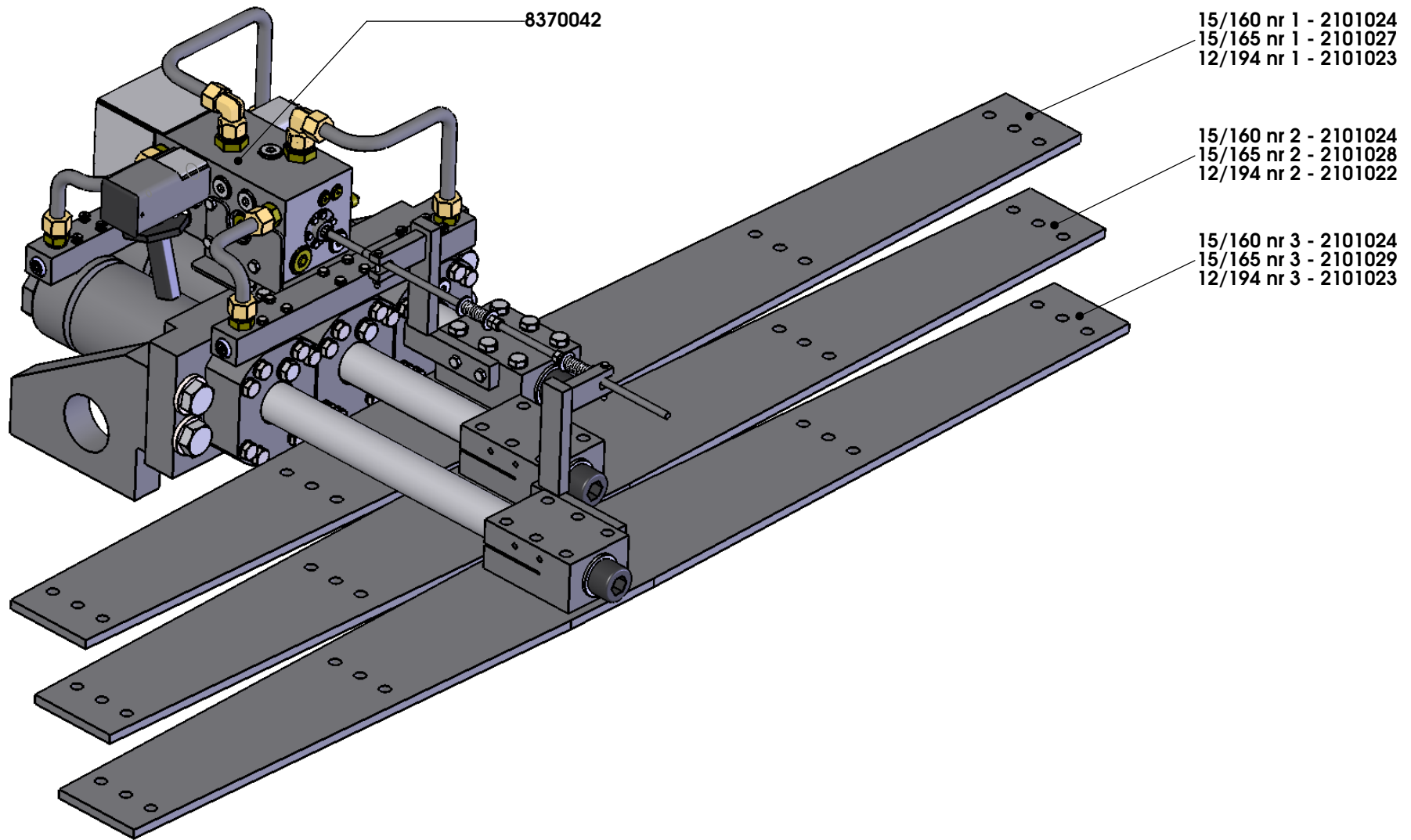

Cargo Floor B.V.
Byte 14
NL-7741 MK Coevorden
Phone : +31-524-593900
Fax : +31-524-593999
E-mail : info@cargo-floor.com

Project: **EXPLODED VIEWS CF3LP-2**

Subject: **Drive unit**

Date: 19-12-2013

Drawn: SK

Drw. nr.: **EV50002-LP-200**

A3

This drawing and the information contained herein is for general presentation purposes only.
This drawing is not intended for use on engineering plans and can be used as "as-is".
This drawing is the property of Cargo Floor B.V. and must not be copied or reproduced without their written authority.

Page 1

ART. NR. Nº DE PEDIDO	AANDRIJFUNIT PAGINA 1 BENAMING	UNIDADES DE ACCIONAMIENTO PÁGINA 1 DESCRIPCIÓN	PRIJS PRECIO
2101022	Framevoet CF3LP-2 nr. 2 (12/194)	Travesano móvil estructura CF3LP-2 no. 2 (12/194)	
2101023	Framevoet CF3LP-2 nr. 1/3 (12/194)	Travesano móvil estructura CF3LP-2 no. 1/3 (12/194)	
2101024	Framevoet CF3LP-2 nr. 1/2/3 (15/160) verzinkt	Travesano móvil estructura CF3LP-2 no. 1/2/3 (15/160) galvanizado	
2101027	Framevoet CF3LP-2 nr. 1 (15/165)	Travesano móvil estructura CF3LP-2 no. 1 (15/165)	
2101028	Framevoet CF3LP-2 nr. 2 (15/165)	Travesano móvil estructura CF3LP-2 no. 2 (15/165)	
2101029	Framevoet CF3LP-2 nr. 3 (15/165)	Travesano móvil estructura CF3LP-2 no. 3 (15/165)	
8370042	Besturingsventiel 02 B-bediend (compleet)	Válvula de control 02 "B" (completo)	
<p>Prijzen: per stuk in EURO, excl. B.T.W.</p> <p>Levering: af werk, volgens onze standaard leverings- en betalingsvoorwaarden</p> <p>Betaling: netto, binnen 14 dagen na factuurdatum</p> <p>Wijzigingen voorbehouden.</p>		<p>Precios: en EUROS, IVA excl.</p> <p>Entrega: De fábrica, de acuerdo con nuestros términos de pago y entrega</p> <p>Pago: neto, 14 días pagaderos desde la fecha de la factura</p> <p>Reservado el derecho a realizar cambios</p>	

 +31 524 593 900

 info@cargofloor.com

www.cargofloor.com

FOR INFORMATION ONLY !

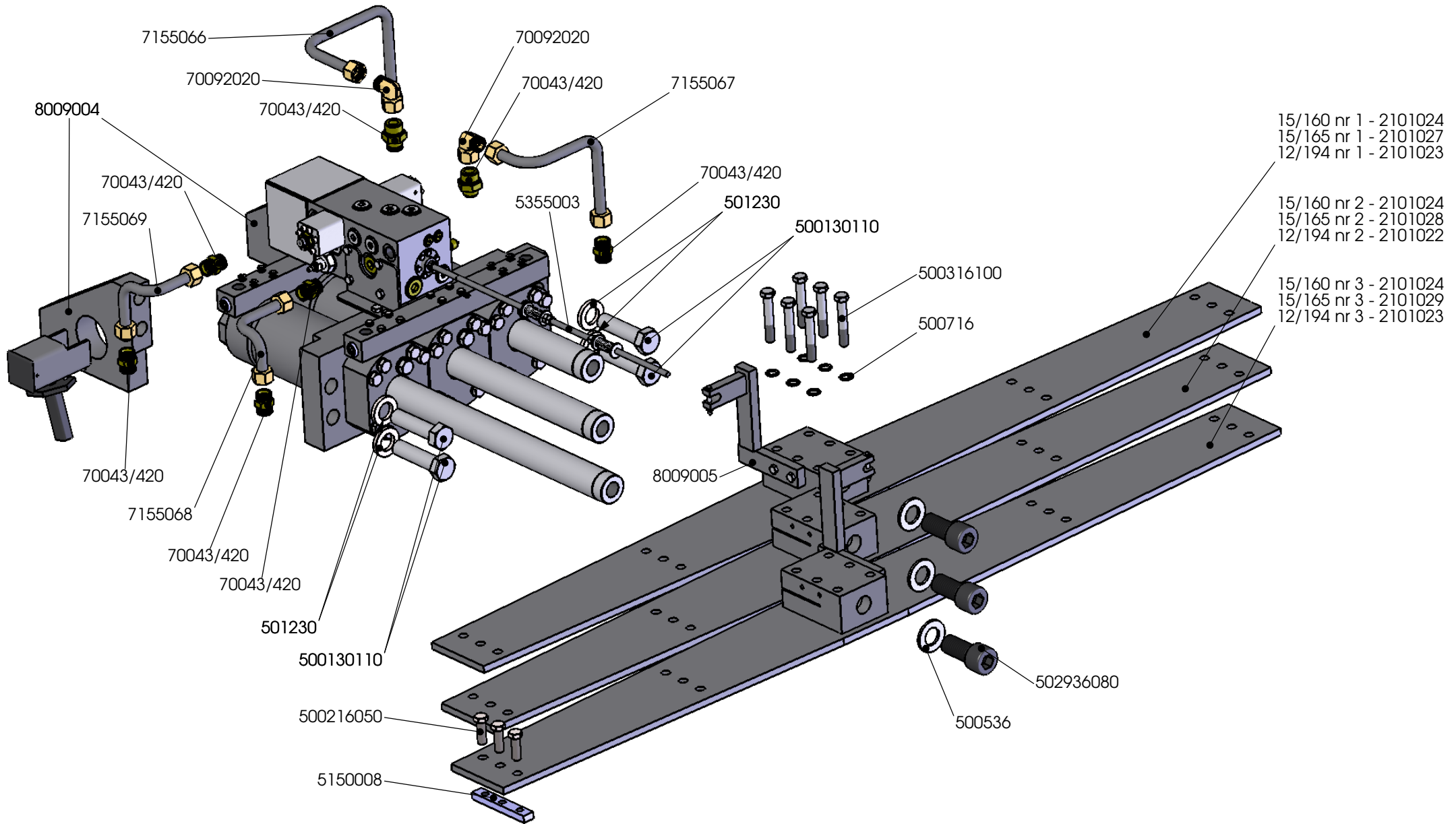

Cargo Floor B.V.
 Byte 14
 NL-7741 MK Coevorden
 Phone : +31-524-593900
 Fax : +31-524-593999
 E-mail : info@cargo-floor.com

Project: **EXPLODED VIEWS CF3LP-2**

Subject: **Cylinder, piping, cross members, braces**

Date: 19-12-2013

Drawn: SK

Drw. nr.:

EV50002-LP-202

A3

This drawing and the information contained herein is for general presentation purposes only. This drawing is not intended for use on engineering plans and can be used as "as-is". This drawing is the property of Cargo Floor B.V. and must not be copied or reproduced without their written authority.

ART. NR. Nº DE PEDIDO	CILINDERS, LEIDINGEN, FRAMEVOETEN EN STEUNEN PAGINA 2 BENAMING	CILINDROS, TUBOS, TRAVESANO ESTRUCTURA, SOPORTE DE MONTAJE PÁGINA 2 DESCRIPCIÓN	PRIJS PRECIO
501230	Veerring M30 elvz	CF3-LP Anillo resorte M30 elvz	
500536	Sluistring M36 elvz (vlak)	Arandela plana M36 galvanizada	
500716	Borgring M16 (Nord-lock)	Arandela a prueba de vibraciones	
2101022	Framevoet CF3LP-2 nr. 2 (12/194)	Travesano móvil estructura CF3LP-2 no. 2 (12/194)	
2101023	Framevoet CF3LP-2 nr. 1/3 (12/194)	Travesano móvil estructura CF3LP-2 no. 1/3 (12/194)	
2101024	Framevoet CF3LP-2 nr. 1/2/3 (15/160) verzinkt	Travesano móvil estructura CF3LP-2 no. 1/2/3 (15/160) galvanizado	
2101027	Framevoet CF3LP-2 nr. 1 (15/165)	Travesano móvil estructura CF3LP-2 no. 1 (15/165)	
2101028	Framevoet CF3LP-2 nr. 2 (15/165)	Travesano móvil estructura CF3LP-2 no. 2 (15/165)	
2101029	Framevoet CF3LP-2 nr. 3 (15/165)	Travesano móvil estructura CF3LP-2 no. 3 (15/165)	
5150008	Montagestrip CF3 LP (3 x M16 L=150 mm)	Tira de montaje CF3 LP(3 x M16 L=150 mm)	
5355003	Draadstang compleet (1000 mm.)	Barra roscada completo (1000 mm [39.4"])	
7155066	Hydraulische leiding nr. 1 (besturingsventiel 02/CF3LP-2)	Tubo hidráulico nº 1 (válvula de control 02/CF3LP-2)	
7155067	Hydraulische leiding nr. 2 (besturingsventiel 02/CF3LP-2)	Tubo hidráulico nº 2 (válvula de control 02/CF3LP-2)	
7155068	Hydraulische leiding nr. 3 (besturingsventiel 02/CF3LP-2)	Tubo hidráulico nº 3 (válvula de control 02/CF3LP-2)	
7155069	Hydraulische leiding nr. 4 (besturingsventiel 02/CF3LP-2)	Tubo hidráulico nº 4 (válvula de control 02/CF3LP-2)	
8009004	Lassteun CF3LP-2	SopORTE de soldadura CF3LP-2	
70092020	Stelbare haakse koppeling 20 x 20 mm.	Acoplamiento cuadrado regulado 20 x 20mm	
500130110	Zeskantbout M30x110	Perno hexagonal M30x110	
500216050	Zeskanttapbout M16x50 elvz	Tornillo de cabeza hexagonal M16 x 50 galvanizado	
500316100	Zeskanttapbout M16x100 zwart (10.9)	Tornillo hexagonal M16x100 negro (10.9)	
502936080	Inbusbout M36x80	Tornillo de cabeza cilíndrica M36x80	
70043/420	Rechte inschroefkoppeling 3/4" x 20 mm.	Tuerca de unión macho 3/4" x 20 mm.	
	Prijzen: per stuk in EURO, excl. B.T.W. Levering: af werk, volgens onze standaard leverings- en betalingsvoorwaarden Betaling: netto, binnen 14 dagen na factuurdatum Wijzigingen voorbehouden.	Precios: en EUROS, IVA excl. Entrega: De fábrica, de acuerdo con nuestros términos de pago y entrega Pago: neto, 14 días pagaderos desde la fecha de la factura Reservado el derecho a realizar cambios	

 +31 524 593 900

 info@cargofloor.com

www.cargofloor.com

FLOOR PROFILE

10/133 Leak Proof Deckslat HD (Heavy Duty)
 Artikelnr. : 89.3497

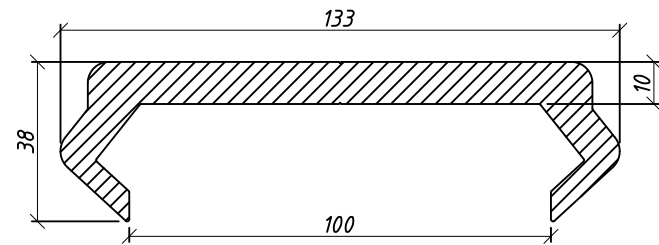

7/133 Leak Proof Deckslat Standaard
 Artikelnr. : 891.4460

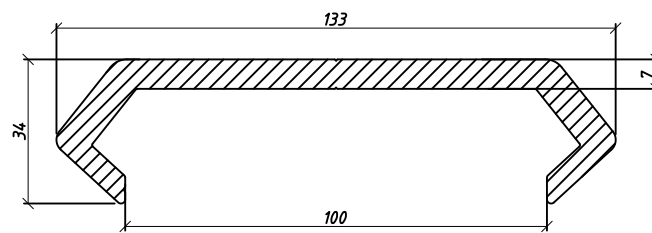

6/155 Leak Proof Deckslat smooth (refrigerated trailer)
 Artikelnr. : 84.6149

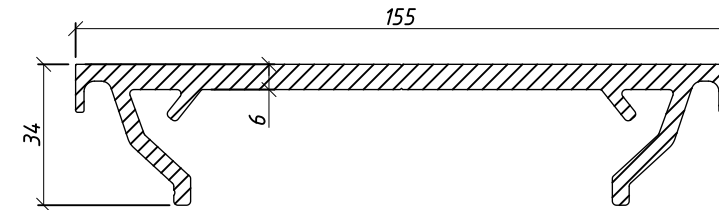

6/160 Leak Proof Deckslat SEALED
 Artikelnr. : 86.6313

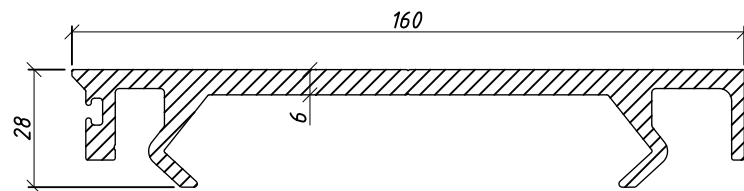

6/160 Leak Proof Gutter sealprofile
 Left L=250mm Artikelnr. : 5448011
 Right L=250mm Artikelnr. : 5448012

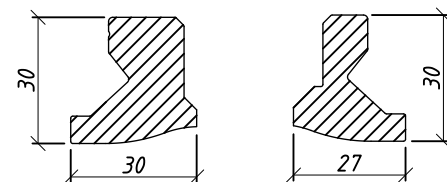

8-20/160 Leak Proof Deckslat HD-SEALED
 Artikelnr. : 862.7825

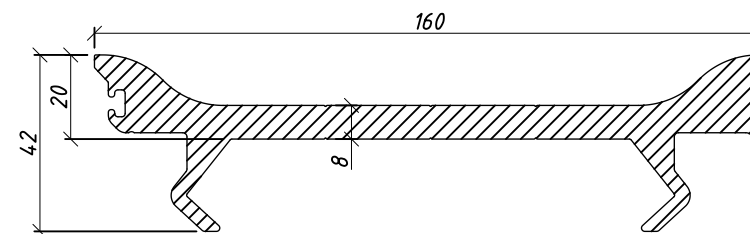

8-20/160 Leak Proof Gutter side-sealprofile
 Artikelnr. : 5448013 (L=250mm)

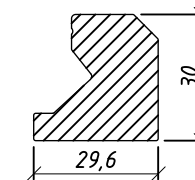

Plastic glider bearing T-subdeck LP
 Artikelnr. : 4107022.01 and 4107022.02

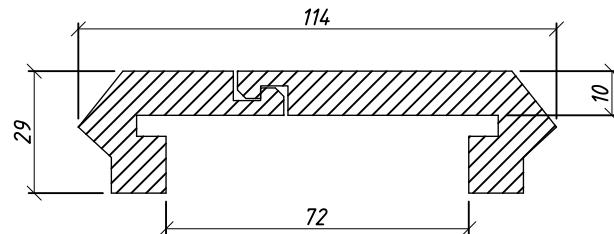

Plastic glider bearing T-subdeck LP with finger-opening
 Artikelnr. : 4107045

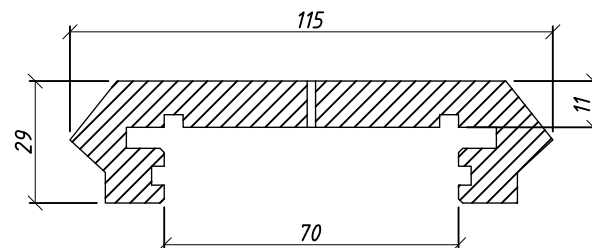

Aluminium endstop T-subdeck LP floor
 Artikelnr. : 5448006
 L=350mm

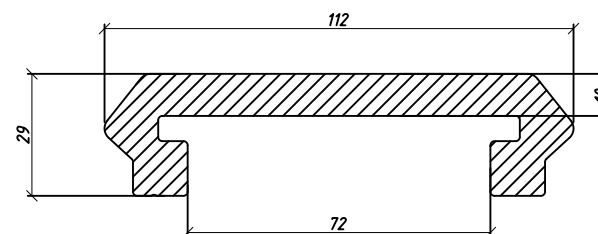

T-SUBDECK PROFILES

Alu 8/160 Leak Proof T subdeck (Slide-in)
 Artikelnr. : 871.5177

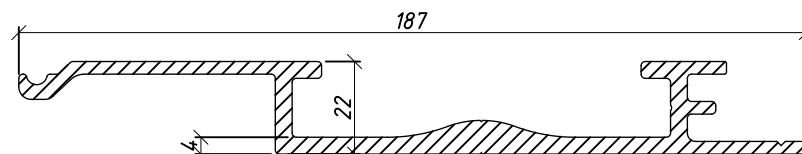

(SLIDE-IN)

Alu 8/160 Leak Proof T subdeck (Turn-in)
 Artikelnr. : 871.4327



(TURN-IN)

Alu 4/160, LR/LP, T-subdeck plane gutter area (slide-in)
 Artikelnr. : 862.7827

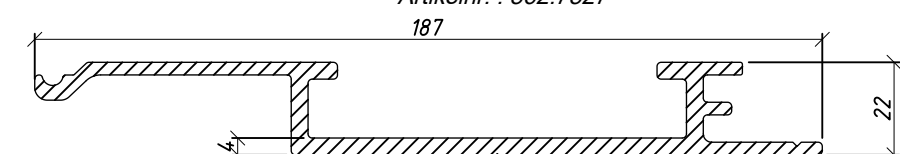

(SLIDE-IN)



Cargo Floor B.V.
 Byte 14
 NL-7741 MK Coevorden
 Phone : +31-524-593900
 E-mail : info@cargofloor.com



PROJECT:
Exploded views CF3LP
 SUBJECT:
Overview Floor

All rights strictly reserved. Reproductions or issue to third parties in any form whatever is not permitted without written authority from the proprietor.

ORDER: ---
 DATE: 20-07-06
 DRAWN: Braakman

F	25-02-19	Diverse toevoegingen	ES
E	21-02-18	T-solid glider update	ES
D	24-01-14	Art.nr + maataanduiding	SK
C	17-01-14	Arcering + tekst	MP
B	16-12-13	Profielen aanpassen	SK
A	18-08-10	Profielen aanpassen	HZ
REV	DATE	CHANGES	BY

PAGE
3
 DRAWING NUMBER :
EV3LP001-CF-223

ART. NR. Nº DE PEDIDO	VLOERDELEN PAGINA 3 BENAMING	PERFILES PÁGINA 3 DESCRIPCIÓN	PRIJS PRECIO
84.6149	Alu profiel 6/155mm glad koeltrailer	Alu perfil 6/155mm liso para remolque refrigerado	
86.6313	Alu. vloerprofiel "deckslat", LR/LP-serie, 6/160 SEALED	Alu "deckslat", LP/LR series 6/160 SEALED	
89.3497	Alu 10/133mm Leak Proof deckslat HD(heavy duty)	Alu 10/133mm Perfil Leak-Proof deckslat HD (Heavy Duty)	
4107045	Kunststof geprofileerd massief afdichtingsprofiel voor T-subdeck (locatie montagevinger), LR-series. opm. altijd per vloerprofiel 2 stuks nodig welke zijdelings in elkaar schuiven L=760mm.	Perfil de plástico sólido estanco para T-subdeck	
5448006	Aluminium eindstop T-subdeck LP vloer (350 mm)	Final de carrera en aluminio para suelo LP T-Subdeck (350 mm [13.78"])	
5448011	Alu. goot afsluitprofiel links t.b.v. "deckslat" SEALED (L=250mm)	Perfil de retención de canaleta de aluminio adecuado para «listón» SELLADO (L=250 mm)	
5448012	Alu. goot afsluitprofiel rechts t.b.v. "deckslat" SEALED (L=250 mm)	Perfil de retención de canaleta de aluminio adecuado para «listón» SELLADO (L=250 mm)	
5448013	Alu zijprofiel voor LR/LP-serie, 8-20/160 mm HD sealed (L.= 250 mm)	Perfil lateral de aluminio para serie LR/LPs, 8-20 160 mm HD sellado (L.= 250 mm)	
862.7825	Alu 8-20/160mm deckslat HD SEALED voor LR/LP-series	Alu 8-20/160mm deckslat HD SEALED para LR/LP-series	
862.7827	Alu LIGHTWEIGHT T-subdeck 4/160mm (slide-in) plane gutter area, alleen voor SEALED LR/LP series	Alu LIGHTWEIGHT T-subdeck 4/160mm (slide-in) plane gutter area, solo para SEALED LR/LP series	
871.4327	Alu 8/160mm Leak Proof T subdeck (Turn-in)	Alu 8/160mm Leak Proof T subdeck (Turn-in)	
871.5177	Alu 8/160mm Leak Proof T subdeck (Slide-in) voor alu/staal	Alu 8/160mm Leak Proof T subdeck (Slide-in)	
891.4460	Alu 7/133mm Leak Proof deckslat standaard	Alu 7/133mm Leak Proof deckslat estándar	
4107022.01	Kunststof geleidingsprofiel massief, ½ deel type A behorend bij deel B, LP/LR serie (Alu 133 LP,T-groef 84 mm.) l=2000 mm. Standaard	Patín de plástico macizo, ½ pieza tipo A perteneciente a pieza B, serie LP/LR (alu 133 LP, hendidura en T 84 mm), l=2000 mm estándar	
4107022.02	Kunststof geleidingsprofiel massief, ½ deel type B behorend bij deel A, LP/LR serie (Alu 133 LP,T-groef 84 mm.) l=2000 mm. Standaard	Patín de plástico macizo, ½ pieza tipo B perteneciente a pieza A, serie LP/LR (alu 133 LP, hendidura en T 84 mm), l=2000 mm estándar	
	<p>Prijzen: per stuk in EURO, excl. B.T.W.</p> <p>Levering: af werk, volgens onze standaard leverings- en betalingsvoorwaarden</p> <p>Betaling: netto, binnen 14 dagen na factuurdatum</p> <p>Wijzigingen voorbehouden.</p>	<p>Precios: en EUROS, IVA excl.</p> <p>Entrega: De fábrica, de acuerdo con nuestros términos de pago y entrega</p> <p>Pago: neto, 14 días pagaderos desde la fecha de la factura</p> <p>Reservado el derecho a realizar cambios</p>	

+31 524 593 900

info@cargofloor.com

www.cargofloor.com