

## CARGO FLOOR INSTRUCTIONS FOR USE

Please read our instructions carefully so that the Cargo Floor-system will give you reliable and trouble free service for many years. It tells you exactly how the system is controlled, pump and filter specifications, together with maintenance and failure check list. "We recommend you observe the upper limits of working the system so that a long and trouble free life can be expected.

Should you have any difficulties with the system's operation please do not hesitate to contact your nearest agent.

It is advisable to read particularly the chapter "WARNINGS" on page 2 attentively.

- Warnings	page 2
- Identification tag	page 3
- Stickers	page 4
- Technical specifications Cargo Floor	page 5
- Possibilities of control systems A, B, and E	page 6
- System A	page 7
- System B	page 8
- Remote controls	page 9
- Hydraulic scheme system B	page 10
- System E	page 11
- Drawing 21-planks system CF-150	page 12
- Drawing 21-planks system CF-300	page 13
- Drawing 12-planks system CF-350LP	page 14
- Adjusting the switching-valve	page 15
- Maintenance instructions	page 16
- Important instructions	page 17
- Malfunctions	page 18
- Warranty conditions	page 19
- Various profiles	page 20
- Combination-valve	page 21
- Mounting instructions	page 22

### **WARNING**

No system should be installed or operated without full reference to the “Cargo Floor System Build Book” and there must be an “” Instructions for use manual” available in the language of the system owner.

### **OPERATIONAL WARNING**

- We strongly recommend builders and operators of the Cargo Floor System make certain no person is allowed to stay in the immediate vicinity of the system when it is about to operate.
- Mount suitable machinery guards to the chassis frame.
- During operation, protect the system from people.
- In cases of EMERGENCY the Cargo Floor system can be stopped immediately by:
  - Operate “B” and “E” system remote stop.
  - Operate “B” and “E” system frame mounted stop.
  - Operate manual operation valve to neutral position.
  - Switch off pump motor.
  - Switch off electricity supply.
  - Switch off any powering motor.

	<b>CARGO FLOOR®</b>		<b>TYPE :</b> <input type="text" value="CF"/>
	Cargo Floor B.V. P.O. Box 271 7740 AG COEVORDEN, NL Phone +31 (0)524-593900 Fax +31 (0)524-593999 www.cargofloor.nl		<b>SYST. NR. :</b> <input type="text"/>
	Manufacturers of the "CARGO FLOOR®" selfloader and self-unloader.		<b>PROD. NR.:</b> <input type="text"/>
	PATENTS pending in Europe and in other Continents.		<b>MAX. WP.:</b> <input type="text" value="bar"/>
			<b>MAX. CAP.:</b> <input type="text" value="t"/>
			<b>PROD. YR.:</b> <input type="text"/>

**MEANINGS OF THE FIELDS:**

TYPE : System type  
SYST. NR. : Serial number  
PROD. NR. : Production number  
MAX. WP. : Maximum wording  
MAX. CAP. : Maximum workload  
PROD. YR. : Production year

These stickers, which are delivered with the Cargo Floor systems, should be applied to the vehicle, in the neighbourhood of the described operation;

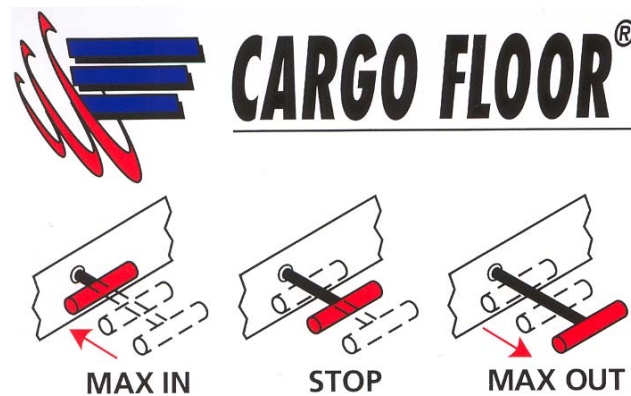
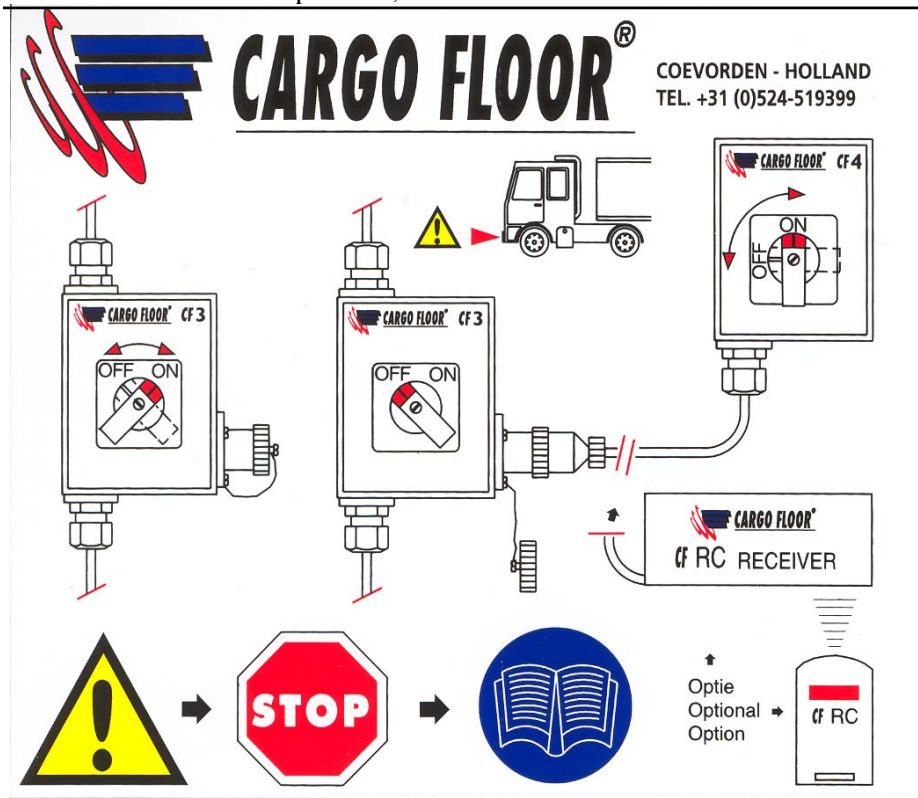

! Voor gebruik altijd de benodigde positie controleren.  
! Vor Gebrauch immer die benötigte Position kontrollieren.  
! Always check the required position before use.  
! Avant usage toujours contrôler la position nécessaire.



COEVORDEN - HOLLAND TEL. +31 (0)524-519399

**TECHNICAL SPECIFICATIONS CARGO FLOOR**

Functioning : hydraulic, by means of three double working cylinders.  
Way of control : mechanic, semi automatic (B-operation), incl. remote control.

	CF150	CF300	CF350
Stroke (mm)	150	200	150
Bore (mm)	80/35	100/45	100/45
Cylinder volume (ltr.)	1.36	2.82	2.11
Oil volume per Cycle (ltr.)	4.08	8.46	6.33
Max. operating pressure (bar)	175	225	225
Overpressure valve set at (bar)	175	225	225
Max. oil flow (ltr./min.)	70	110	110
Strokes per minute	17	13	17
Speed at 110 ltr. oil per minute	2.6	2.6	2.6
Max. pumpcapacity			
Flow (ltr./min.)	70	110	110
Pressure (bar)	250	250	250

On/off switching valve : 24 V  
Way of dosaging : fully variable speed dependant oil flow delivered by engine or by means of multiple pumps.

POWERING : by means of PTO on truck or powersupply.  
Filter : pressure filter type: high pressure 10 micron  
Pressure tubing : Ø 20 x 2.5 ID 15 mm.  
Return tubing : Ø 25 x 2 ID 21 mm.  
Oil ISO VG 32 E.C. : Shell Tellus T32 or BP HLP-32 or ESSO Univis HP 32. (or equivalent)  
Use biologic oil only after contact with Cargo Floor  
Oil temperature : max. 70 °C

**FLOOR**

Aluminium : - max. floorlength on request  
- floor thickness 6 or 10 mm.  
- plank width 112 mm.  
- floor width standard 2,50 mtr.  
Extrusion alloy : high grade Aluminium alloy, weldable, very wear resistant, high yield strength.  
Plastic bearings : the aluminium planks are supported by wear resistant plastic bearings.  
Total surface of each bearing: 87 cm<sup>2</sup>

**UNDERFLOOR**

: Steel or aluminium for bearings provided with square tubes 25 x 25 x 2

**OPTIONS**

: - variable stroke from 10 mm till 200 mm  
- fully automatic control (E-operation), with possibility of PLC control  
- on/off switching valve 12 V of 220 V (24 V=standard)  
- floor planks with steel plates.  
- extra plastic bearings.  
- floor width of 1 mtr. till 3,5 mtr.  
- for special products a fully flat profile can be provided.  
Floor thickness 6 or 100 mm (see page 19)  
- steel of aluminium tubes 25 x 25 x 2 on which plastic bearings are mounted can be provided.  
- wireless remote control

## POSSIBILITIES OF CONTROL SYSTEMS

The Cargo Floor-system can be provided with one of the 3 following controls:

- Control A: manual operation valve (without electricity) see page 7
- Control B: Electric start – stop switch and manual operation valve (loading – unloading). Incl. remote control (R.C.) see page 8, 9 or 10.
- Control E: Electric 3-position switch (loading – stop – unloading). Inclusive remote control see page 11.

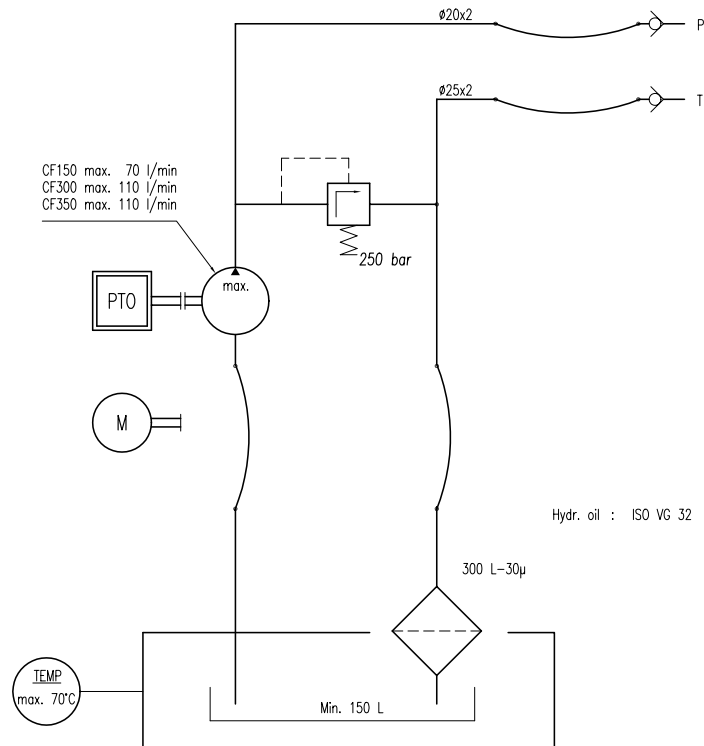

Hydraulic pump unit to power the Cargo Floor system should meet the following specifications.

- Output 20 to 110 ltr./min. (CF150 : max. 70 ltr./min.)  
The pump output determines the transport speed.
- Max. working pressure of 250 Bar
- Oil tank, contents of min. 150 ltr., provided with
  - return filter (30 micron) 300 ltr.
  - tank cover
  - oil level glass
  - draining tap
  - filling cap
- Pressure valve (suitable for 110 ltr./min.), adjusted to 225 Bar
- Other hydraulic tubing should meet the following specifications.
  - Pressure tube min. 20 mm. x 2,5 mm.
  - Return tube min. 25 mm. x 2,5 mm.
- Quick disconnect couplings suited for 110 ltr./min.

## PUT THE SYSTEM INTO OPERATION

Switch on the pump in order to obtain pressure in the Cargo Floor-system. Now the system can be put into operation. Choose the right operation system. Beware that the light is on (only for operation system B/E).

### CONTROL A

Put the shaft of the operation valve, on the combination-valve into the position, loading = shaft pushed in – unloading = shaft pushed out, then the system moves immediately. On putting the lever into the vertical position, the system will stop moving. The shaft in middle position is neutral.

We recommend first to switch the operation valve on loading or unloading before switching on the pump. (**BEWARE THAT THE DOORS ARE OPEN!**)

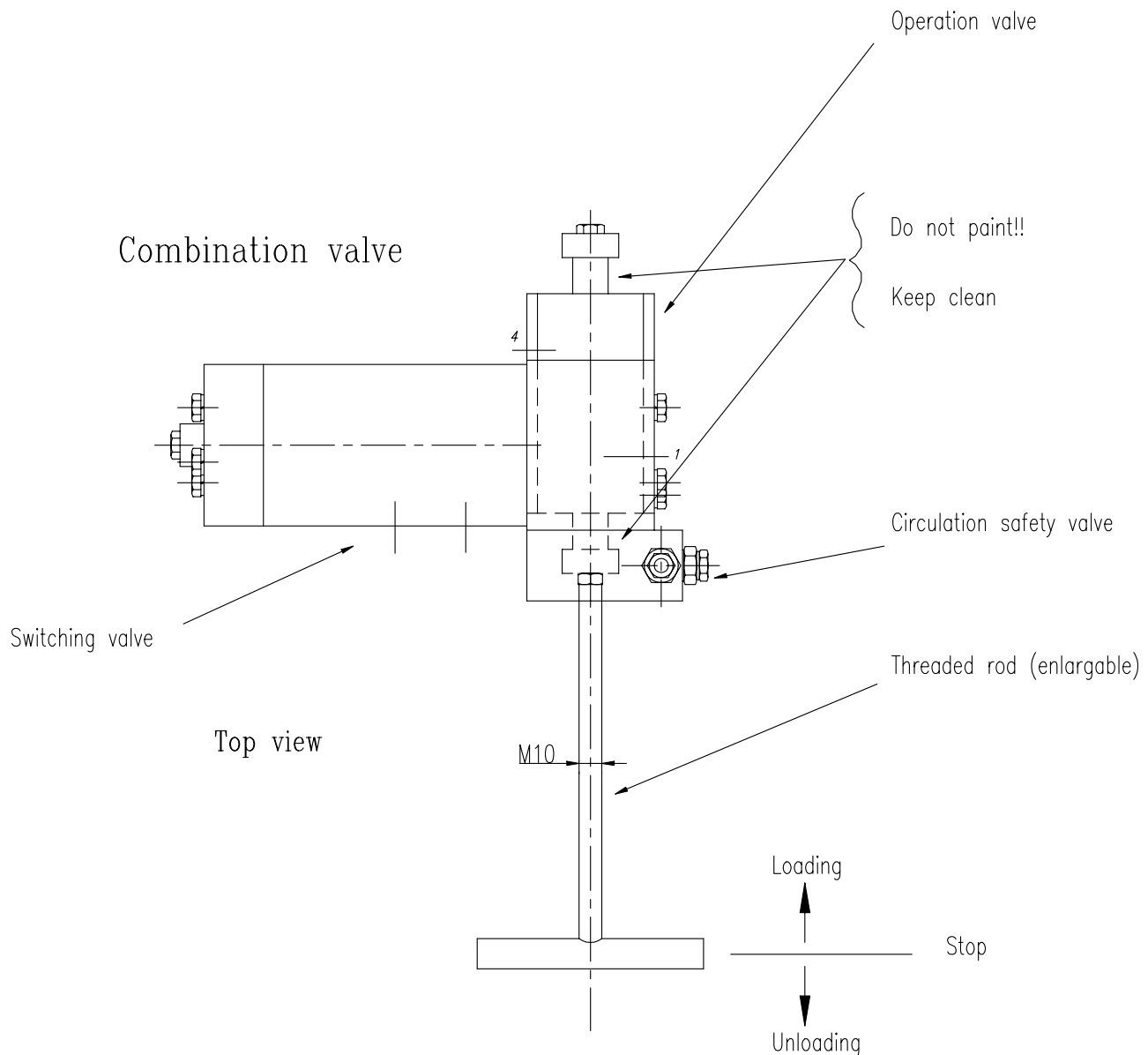

**CONTROL B**

First make your choice for loading or unloading, by means of the operation valve:  
loading = shaft pushed in – unloading = shaft pushed out.

The shaft in middle position is neutral.

Now the system can be switched on or off by means of the electric switch CF 3 or, at distance, with CF 4.

In case of a breakdown the electric valve can be operated by pushing the pin in the circulation valve manually (see drawing).

**(BEWARE THAT THE DOORS ARE OPEN!)**

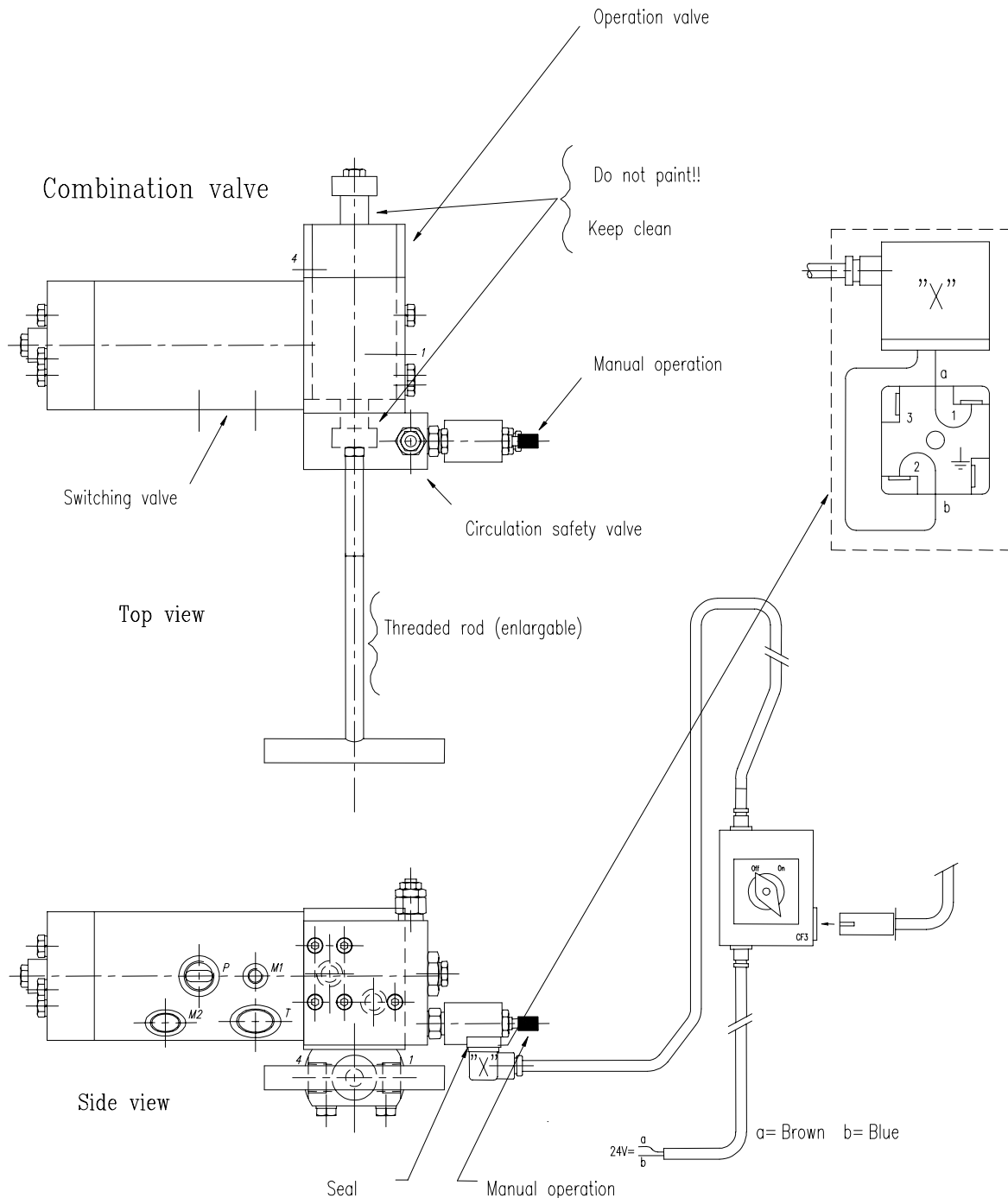



Standard remote control

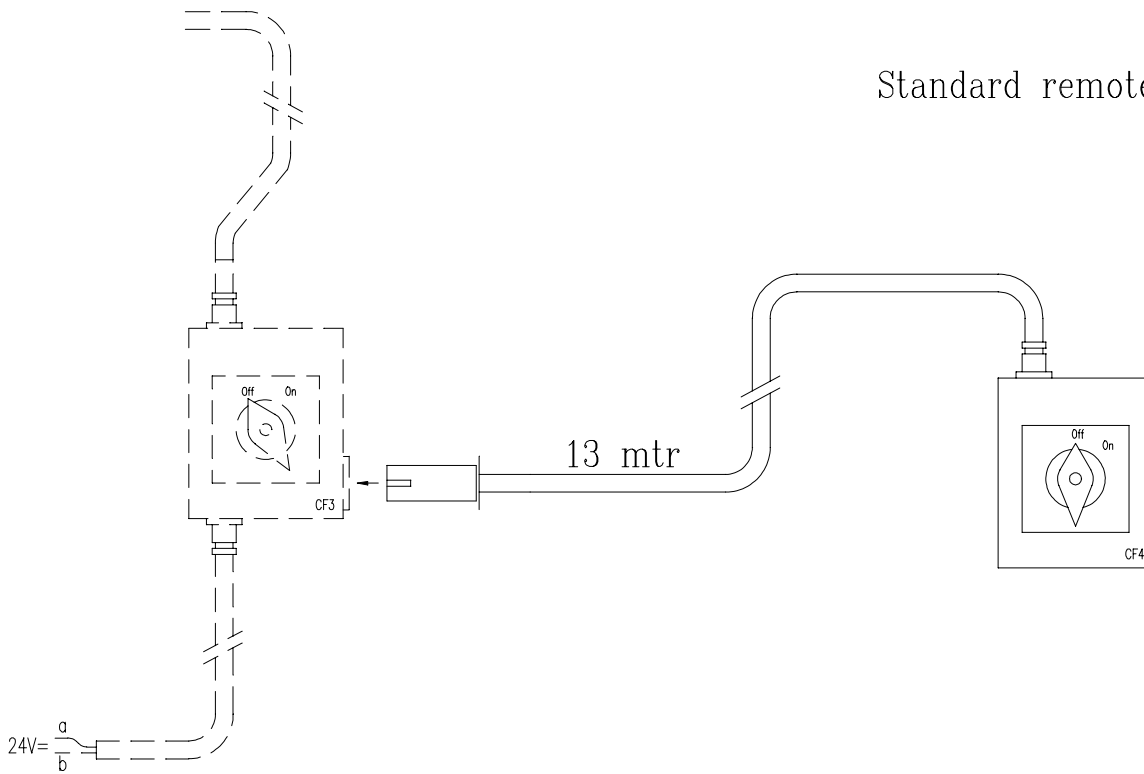

Wireless remote control (optional)

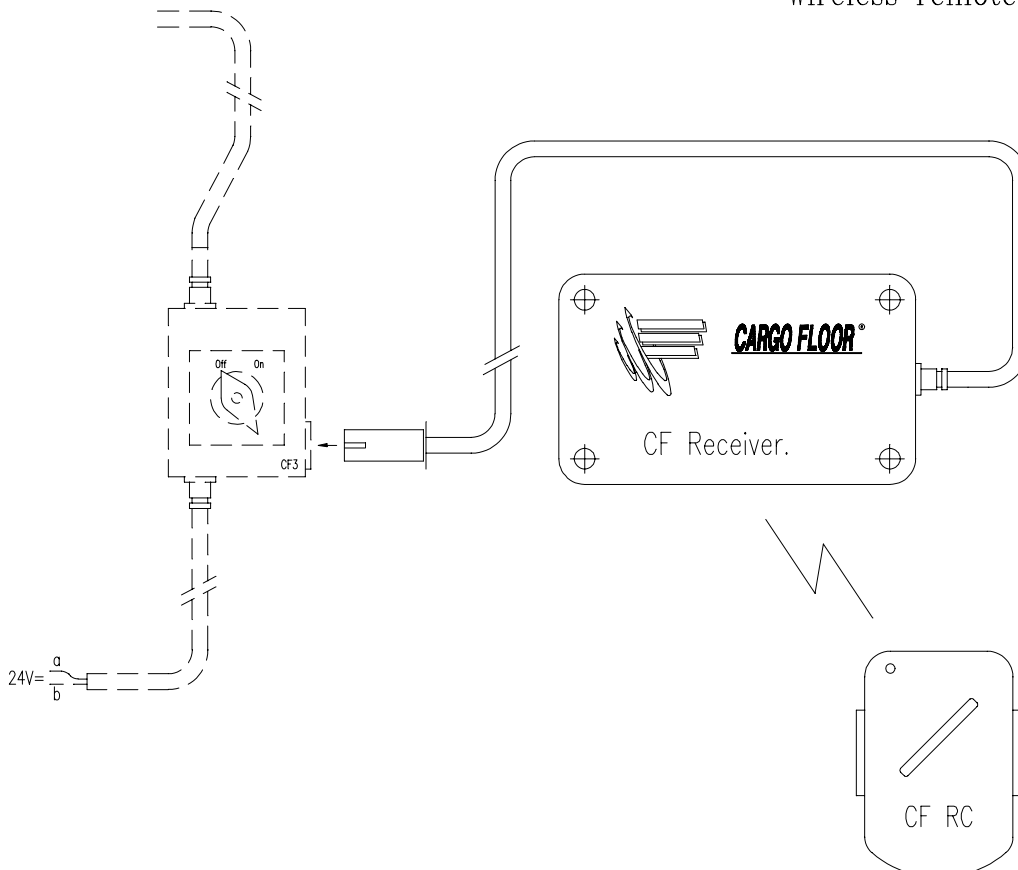

Scheme of hydraulic connection  
for Cargo Floor-system "B".

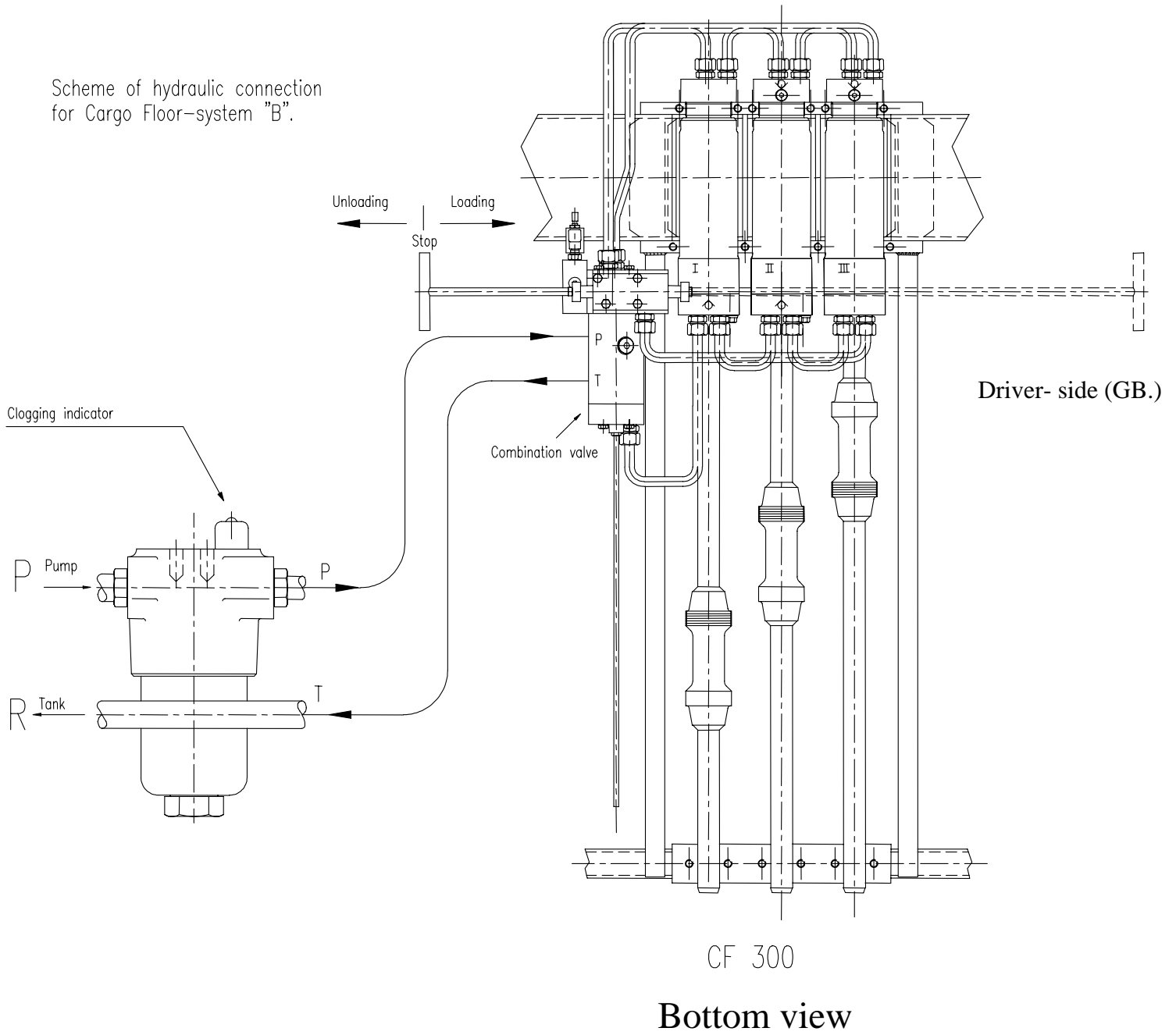

### CONTROL E

First switch on the pump. That Cargo Floor system can be operated by switching the electric switch CF 7 or, at distance with CF 8 on loading – hold – unloading without making a primary choice. In case of an electrical breakdown it is possible to operate the valve by hand (manual operation, see drawing).

**(BEWARE THAT THE DOORS ARE OPEN!)**

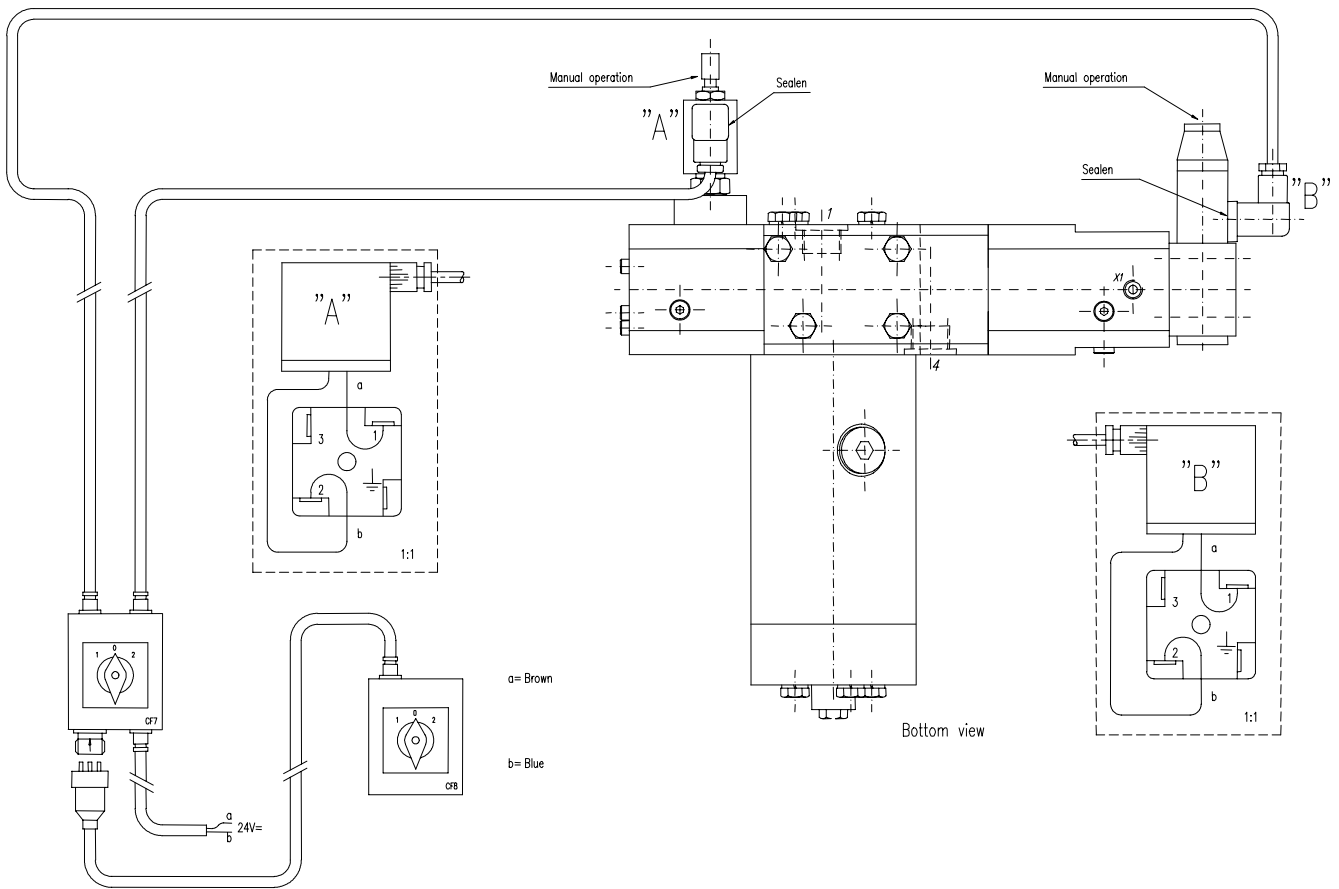

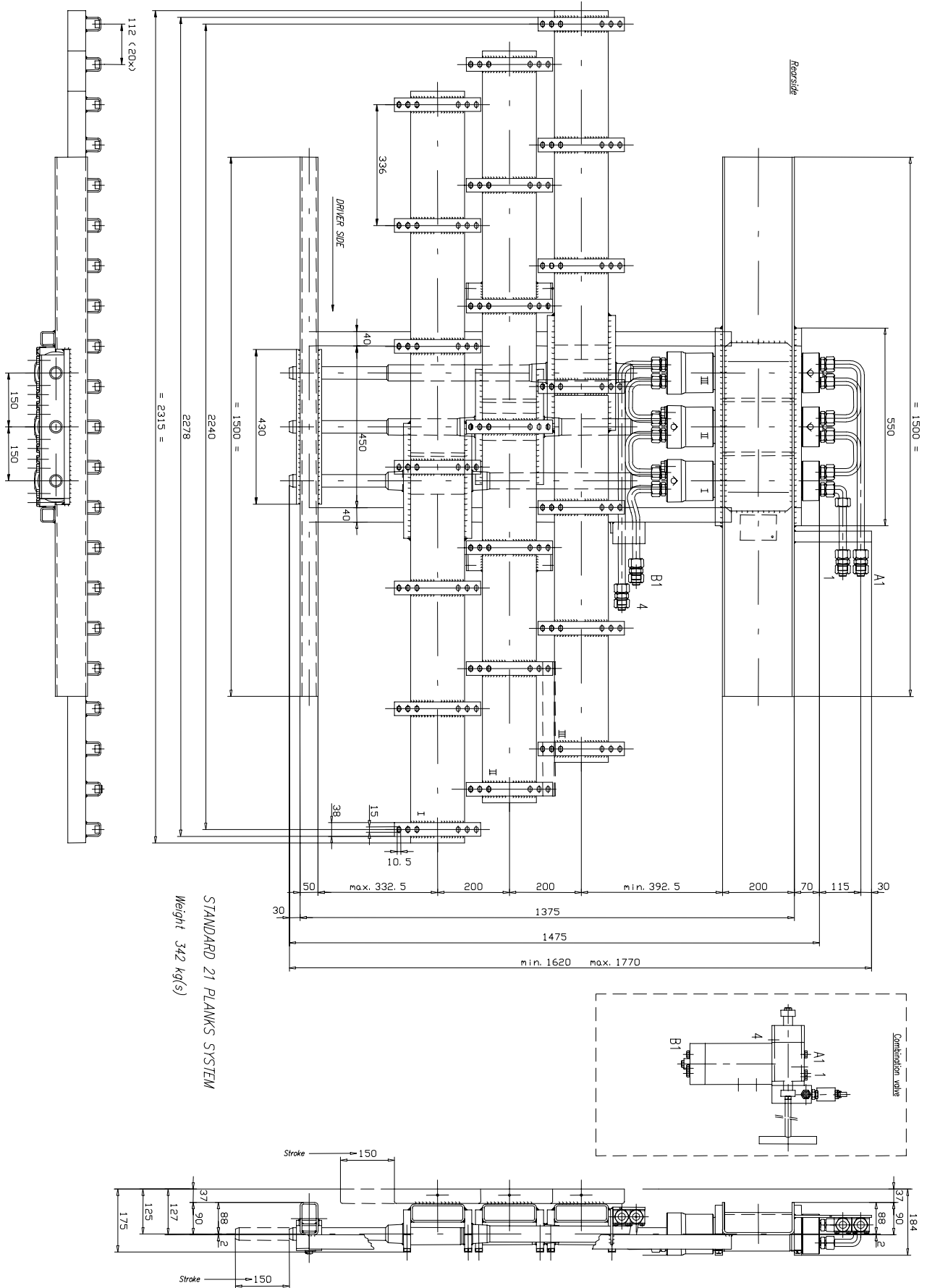

## CF 150-21-112

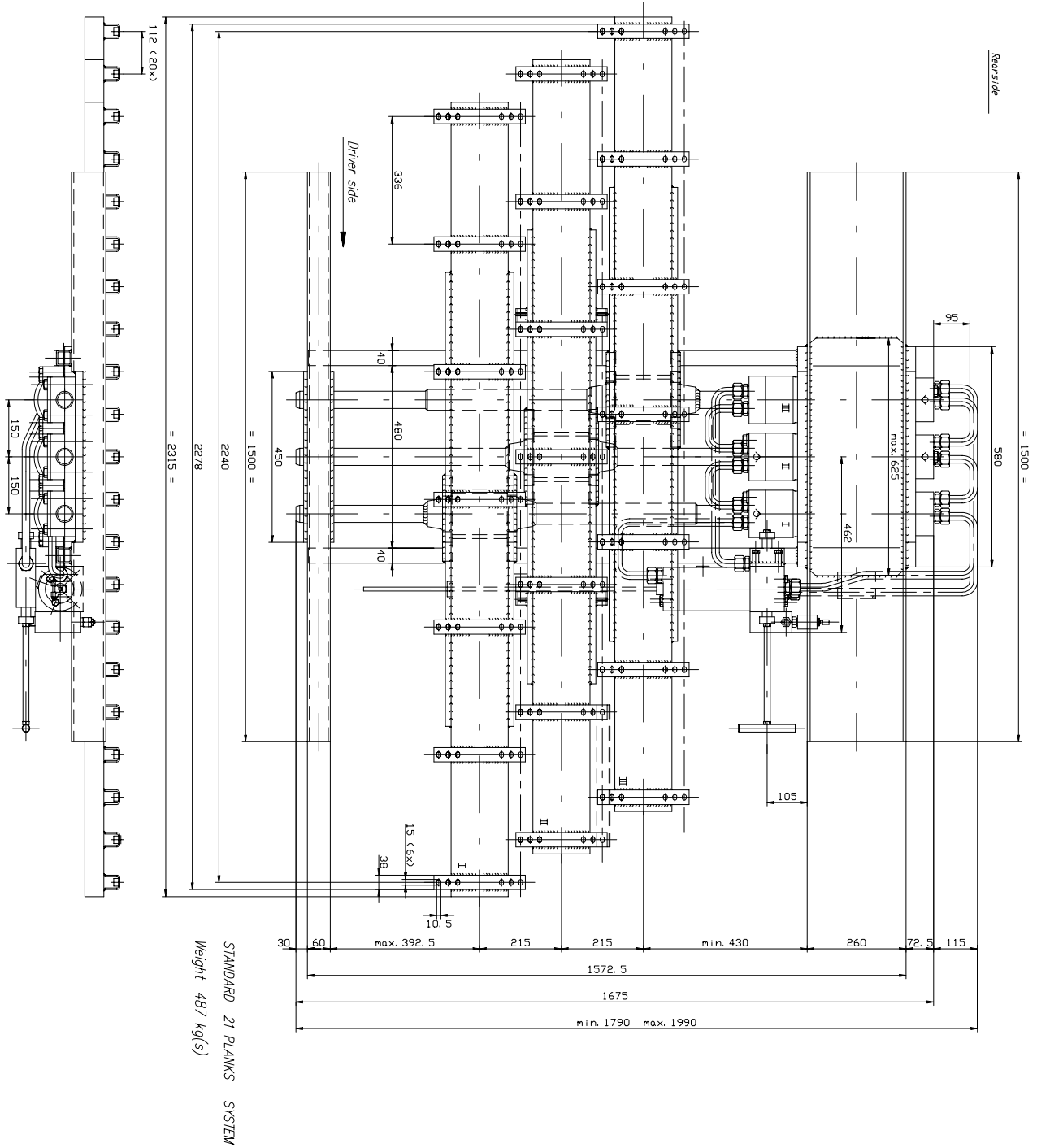

CF 300-21-112

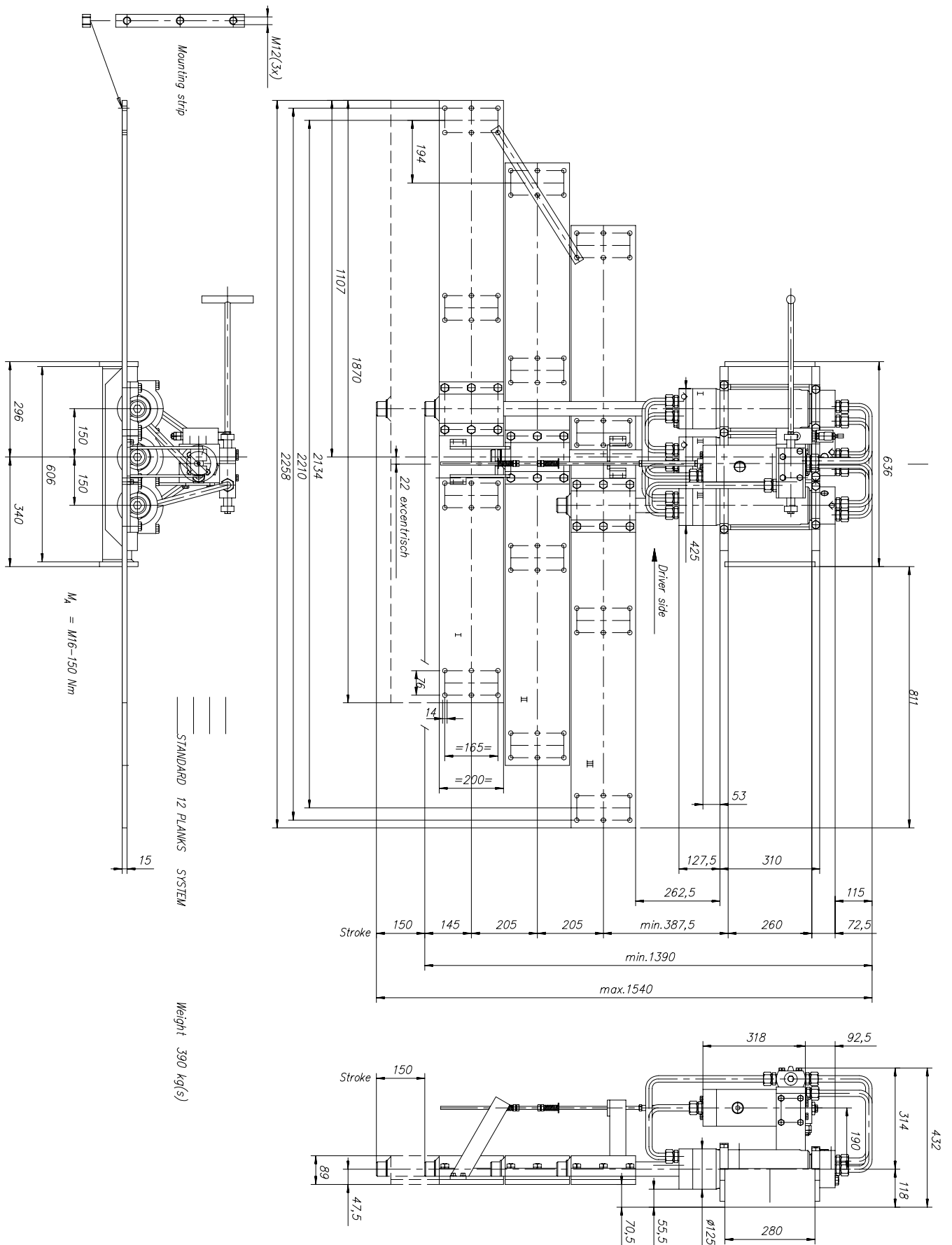

**CF 350 LP**

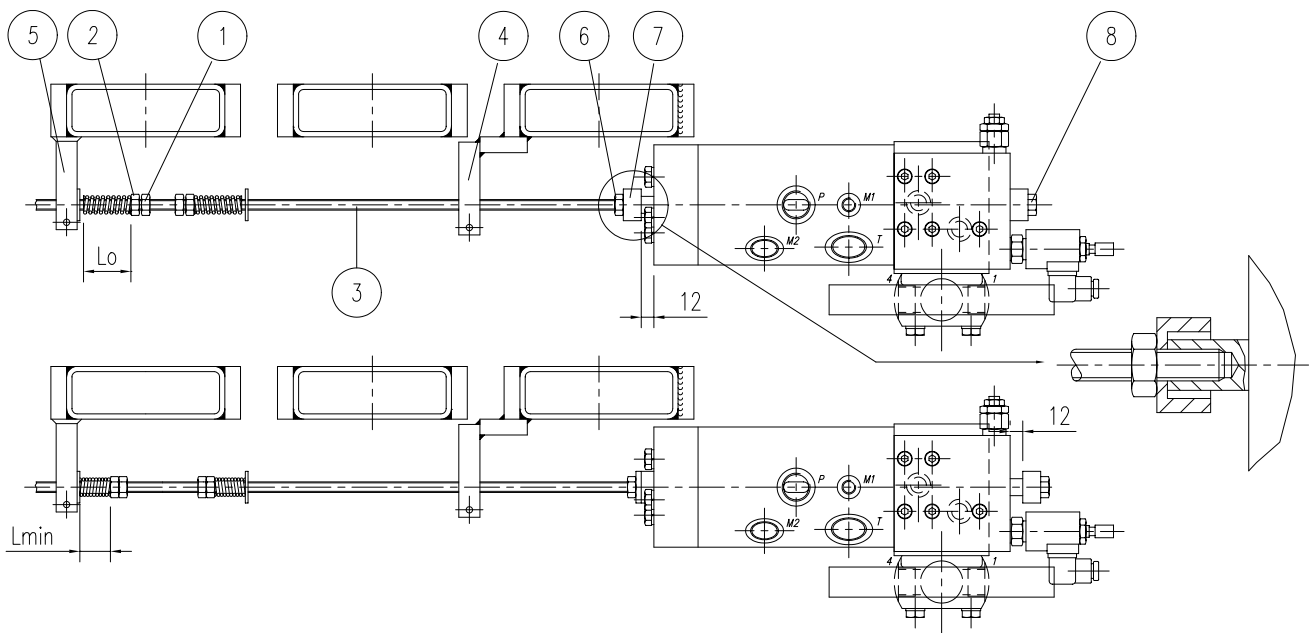

### HOW TO ADJUST THE SWITCHING VALVE

Although the Cargo Floor system itself needs few maintenance, it might be necessary to check and adjust the threaded rod connected onto the switching valve. To do so, act as follows:

Before the actual adjustment, please make sure, that the threaded rod 3 is thoroughly tightened onto the switching valve. If not, tighten it by turning the threaded rod into the shaft of the switching valve as far as possible and lock it with the counter nut (6).

If necessary, you can prevent the shaft in the switching valve from turning and block it with a spanner on bolt 8.

Make sure that the distance ring 7 is mounted correctly (see drawing).

1. Loosen both nuts 1 + 2 and turn them approx. 3 cm to the right so that the combination valve cannot be switched by the commandlip 5.
2. Switch the Cargo Floor on with an unloaded floor.
3. Now the system stops where the switching valve cannot be switched further.  
When the system doesn't stop turn the nuts further back see point 1.
4. Then switch the system off.
5. Push the threaded rod 3 in manually, until the distance ring 7 touches the switching valve.
6. Now turn the nuts 1 + 2 so far in that the springlength is  $L_{min}$  and fasten them by turning the nuts against each other  
Attention! Make sure that the threaded rod is turned into the shaft of the switching valve far enough, then lock the distance ring 7 by tighten nut 6.
7. Repeat this procedure also for other side.

**note: it is advisable to grease the threaded rod 3 with a little copper anti seize.**

## MAINTENANCE INSTRUCTIONS

To enable the Cargo Floor-system to offer you reliable operation it is strongly recommended to observe the following:

- The quality of the oil: This has to be checked regularly (every six months)
- Both the oil and filter element should be replaced every two years, or more frequently if the clogging indicator in the filter turned yellow or red
- quantity of oil in the tank: 150 ltr. oil should be available to avoid excessive heat. Use only hydraulic oil of premium quality, meeting the ISO standard. Viscosity: IOS VG 32, such as Shell Tellus

### Check and clean the following parts:

- If screws are loose, retighten or replace.
- Coupling nuts and couplings form all hydr. components, if necessary replace them.
- Oil tank:  
make sure it is clean and no water vapour has build up
- Return/pressure filter, by removing the cap one can see the filter-elements, pressure filter has a pollution indicator (see page 9), replace after approx. 2 years

Please observe these few points as they will help to avoid inside wear (of p.e. pump and hydraulic cylinders etc.). New elements/parts can be supplied by your agent.  
The cost of regular maintenance is minimal compared to the achieved lifespan of your Cargo Floor system.

- Switching valve:  
Adjustment of the switching valve. It is necessary to adjust the valve now and then (see page 9), replace after approx. 2 years.

Cleaning your Cargo Floor with a steamcleaner should be considered a part of your regular maintenance.



### IMPORTANT INSTRUCTIONS

- Avoid dirt to enter the system when disconnecting the quick disconnect couplings or when refilling the oil tank.
- Adapt the wording speed on loading or unloading heavy products, which need the max. wording pressure (see tabel).
- It is advisable, not to exceed the max. wording pressure (see tabel).
- Although it is possible that the pressure will become higher then the maximum, when heavy, wet materials are leaded it is better to load less because then the system will live longer.
- Never exceed the maximum operation speed per minute, as otherwise the Cargo Floor system will induce unacceptably high stresses in the chassis of your vehicle! (see tabel for maximum speed)
- Starting to unload has to be done slowly until the cargo is moving from the side walls. Increase speed as required.
- During loading and unloading of pallet it is important to use good and even pallet. If they're not, possibly the pallets will not move. This can be solved by placing a wooden board of approx. 12,5 x 1,5 x 240 cm under each pallet (use soft wood).
- Now and then check the clearance between the 2 fixed floor planks and the moving ones. If the clearance is too big, re-adjust the fixed profiles, so that the seal fits correctly and leakage along the sides will be prevented.
- Now and then check the countersink screws in the aluminium planks. Should any play occur, tighten the nuts underneath the floor.

### FAILURE CHECKLIST

Should the system not operate properly, or not operate at all, please check the following points of attention:

1. Is the P.T.O./pump switched on?
  - 1 a. Is the light on so there is electricity?
2. Is there oilpressure? You have to measure this on the therefore present measure points M1 (see tabel for max. pressure) and M2 (returnpressure max. 15 bar) on the switching valve. See page 20

If, so, check the points 3 ,4, 5 and 6

If not, check the points 7 and 8

3. Are the quick couplings properly connected and are the gates opened well?
4. Is the operation valve switched on either loading or unloading (control systems A and B).
5. Check for electrical breakdowns (control systems B and E) by pushing the shafts of the solenoids manually. See also page 7, 8 and 11 at "MANUAL OPERATION".
6. Check the adjustment of the switching valve. (Page 15.)
7. Check the oil level in the tank.
8. Check for oil leaks.

If non of these instructions will be of any help. Please contact your agent or Cargo Floor B.V.

## **WARRANTY CONDITIONS**

The warranty conditions, as put into words in the last text of the general delivery – and payment-terms of Cargo Floor deposited under number 1436 by the Chamber of Commerce in Meppel are unimpaired applicable.

We guarantee the Cargo Floor system for a period of 12 months after building-in. During this period and in the case of defects caused by manufacturing errors or faulty materials, we will supply replacing parts without charge, only if:

- The Cargo Floor system has been mounted according to the assembly instructions
- The system has been used in accordance with the instructions for use.
- In the case of defects, the nearest Cargo Floor agent or Cargo Floor will be informed as soon as possible.

### **Not under guarantee are:**

- defects in, or caused by materials not supplied by us.
- Defects caused by dirt or faulty oil.
- Defects caused by overloading or incorrect use.
- defects caused by repairs carried out by unauthorised people.
- Filter elements and normal ware.
- Electrical breakdowns caused by bad connection or wrong voltage.

### **The guarantee lapses, if,**

- The Cargo Floor system will be used for purpose, not recommended by Cargo Floor.
- The Cargo Floor system has not been built-in in accordance with our assembly instructions, as far as the normal use of the system is effected negatively by this.

**PLANK TYPES**

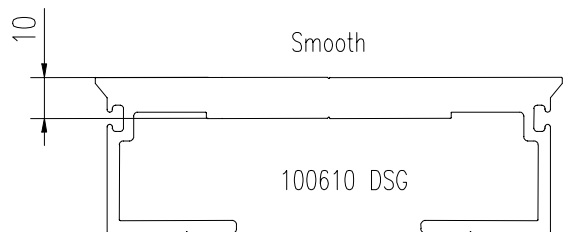
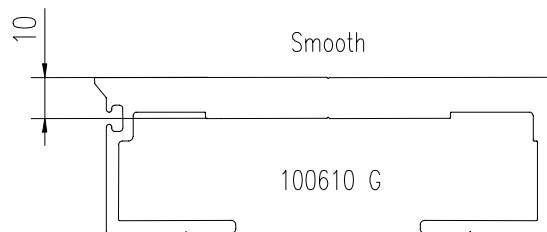
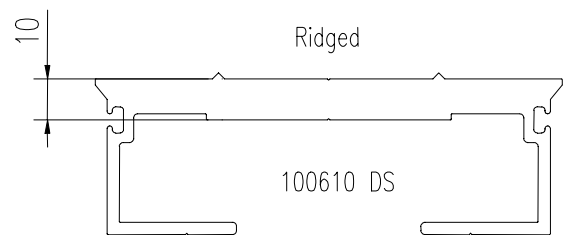
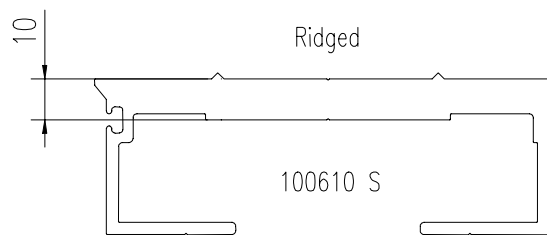
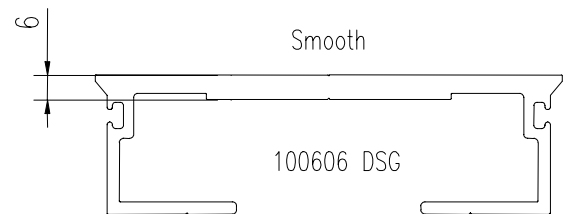
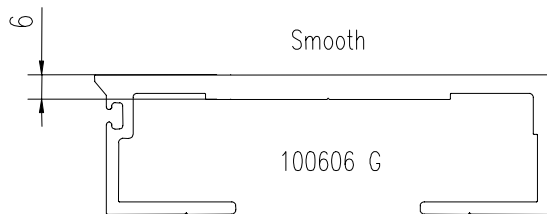
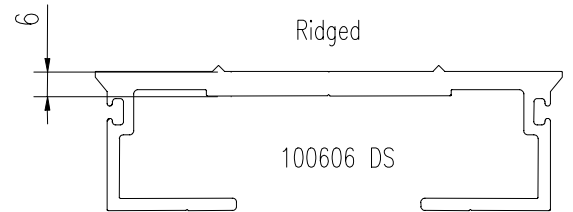
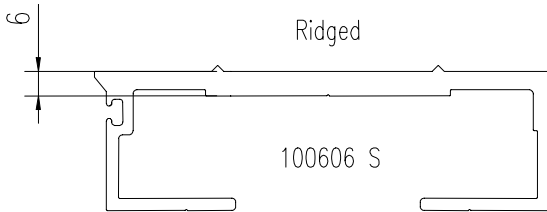

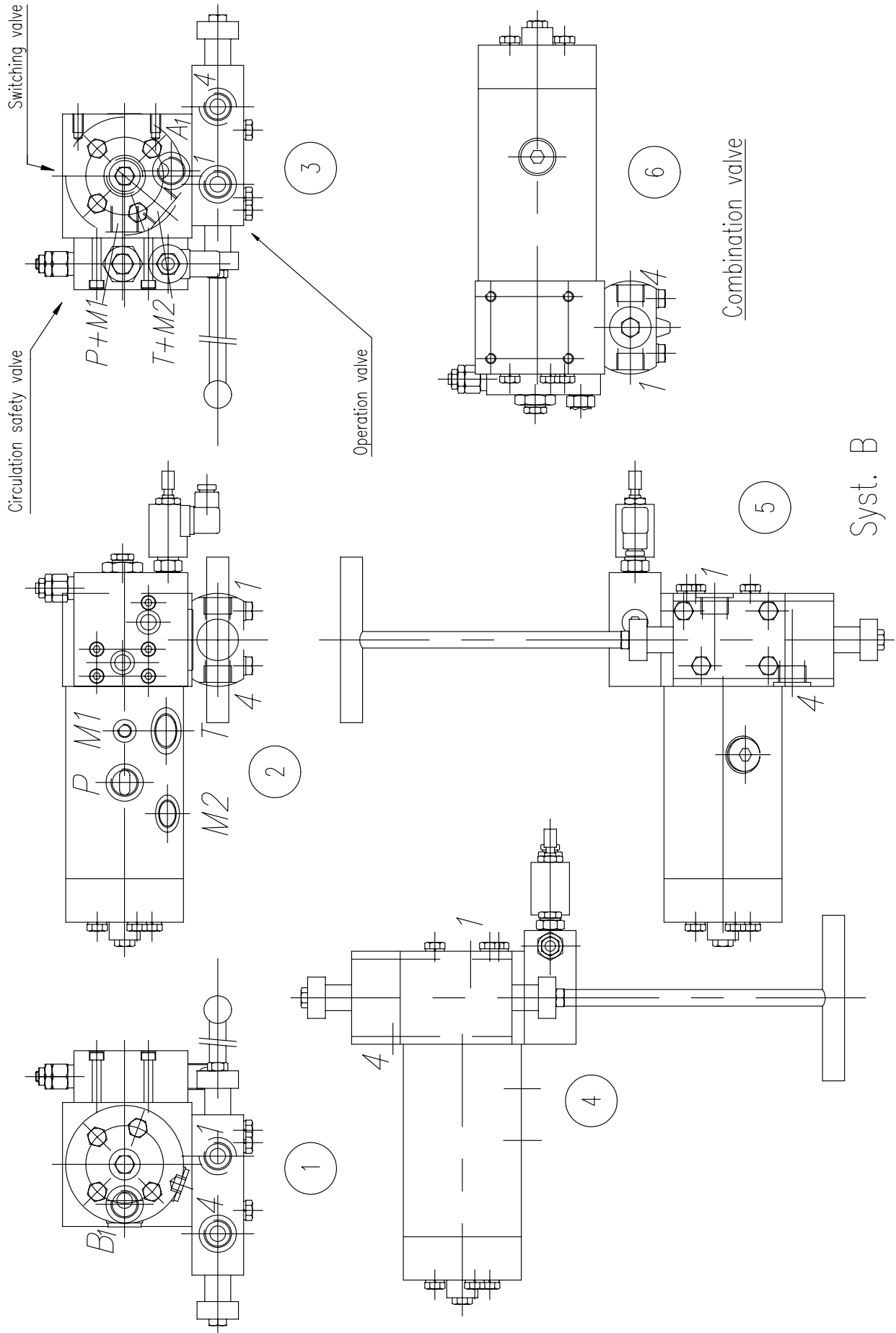

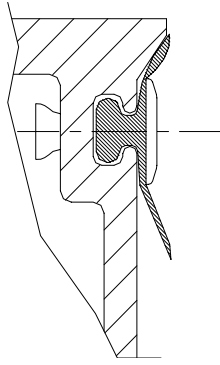

Plastic block

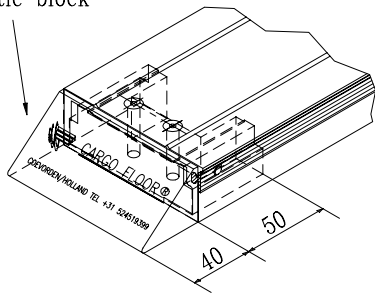

Aluminum block

