

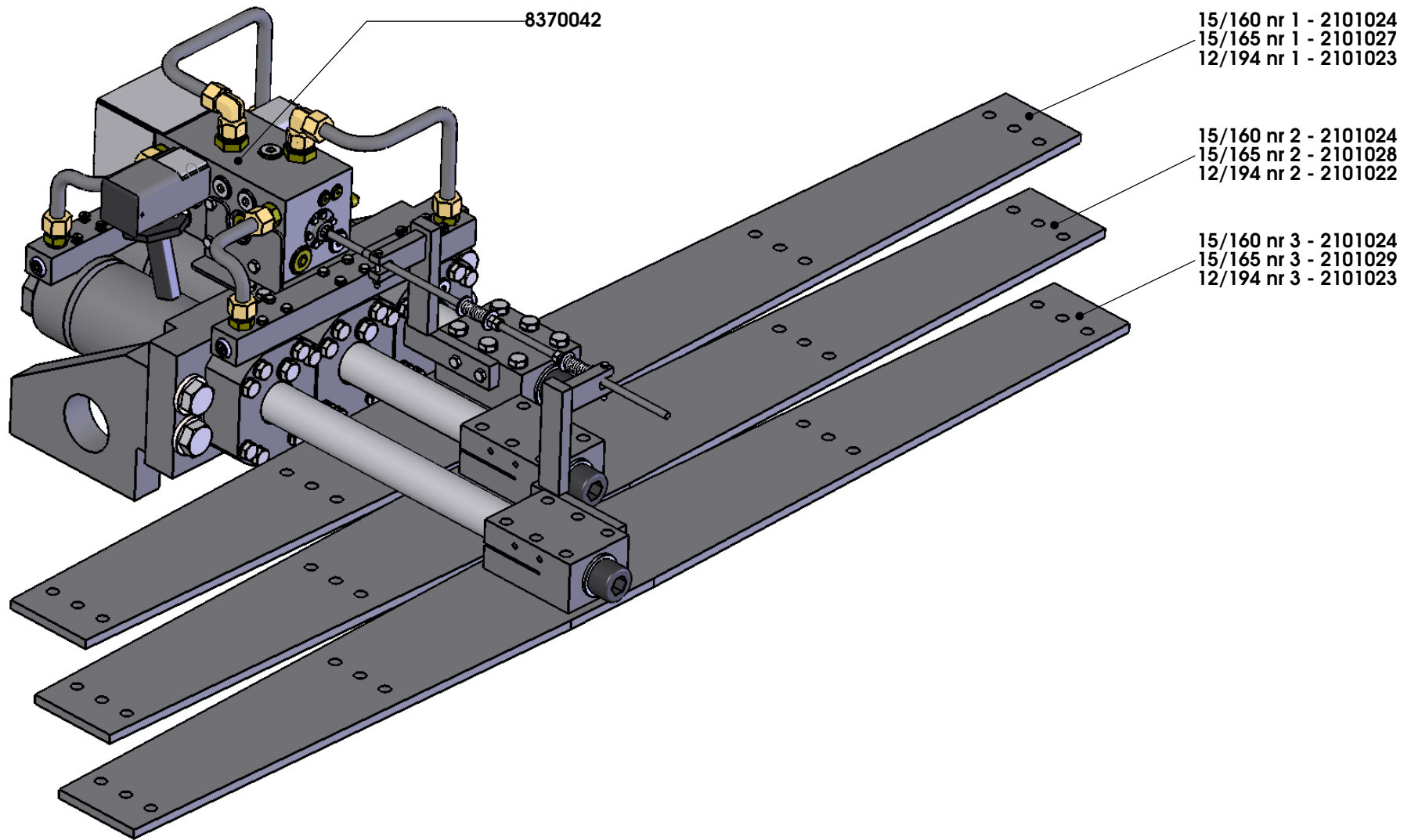

**FOR INFORMATION ONLY !**



Cargo Floor B.V.  
Byte 14  
NL-7741 MK Coevorden  
Phone : +31-524-593900  
Fax : +31-524-593999  
E-mail : info@cargo-floor.com

Project: **EXPLODED VIEWS CF3LP-2**

Subject: **Drive unit**

Date: 19-12-2013

Drawn: SK

Draw. nr.: **EV50002-LP-200**

**A3**

This drawing and the information contained herein is for general presentation purposes only.  
This drawing is not intended for use on engineering plans and can be used as "as-is".  
This drawing is the property of Cargo Floor B.V. and must not be copied or reproduced without their written authority.

**Page 1**

ART. NR. ART. Nº:	AANDRIJFUNIT PAGINA 1 BENAMING	UNIDADES PROPULSORAS PÁGINA 1 DESCRIÇÃO	PRIJS PREÇO
2101022	Framevoet CF3LP-2 nr. 2 (12/194)	Membro cruzado móvel CF3LP-2 no. 2 (12/194)	
2101023	Framevoet CF3LP-2 nr. 1/3 (12/194)	Membro cruzado móvel CF3LP-2 no. 1/3 (12/194)	
2101024	Framevoet CF3LP-2 nr. 1/2/3 (15/160) verzinkt	Membro cruzado móvel CF3LP-2 no. 1/2/3 (15/160), galvanizado	
2101027	Framevoet CF3LP-2 nr. 1 (15/165)	Membro cruzado móvel CF3LP-2 no. 1 (15/165)	
2101028	Framevoet CF3LP-2 nr. 2 (15/165)	Membro cruzado móvel CF3LP-2 no. 2 (15/165)	
2101029	Framevoet CF3LP-2 nr. 3 (15/165)	Membro cruzado móvel CF3LP-2 no. 3 (15/165)	
8370042	Besturingsventiel 02 B-bediend (compleet)	Válvula de controlo 02 operação B (completa)	
<p>Prijzen: per stuk in EURO, excl. B.T.W.</p> <p>Levering: af werk, volgens onze standaard leverings- en betalingsvoorwaarden</p> <p>Betaling: netto, binnen 14 dagen na factuurdatum</p> <p>Wijzigingen voorbehouden.</p>		<p>Preços: unitário em EUROS, IVA não incluído</p> <p>Entrega: Ex Works, de acordo com os nossos termos de pagamento e entrega habituais</p> <p>Pagamento: líquido, vencimento a 14 dias a contar da data da fatura</p> <p>Reservados todos os direitos</p>	

 +31 524 593 900

 info@cargofloor.com

[www.cargofloor.com](http://www.cargofloor.com)

# FOR INFORMATION ONLY !

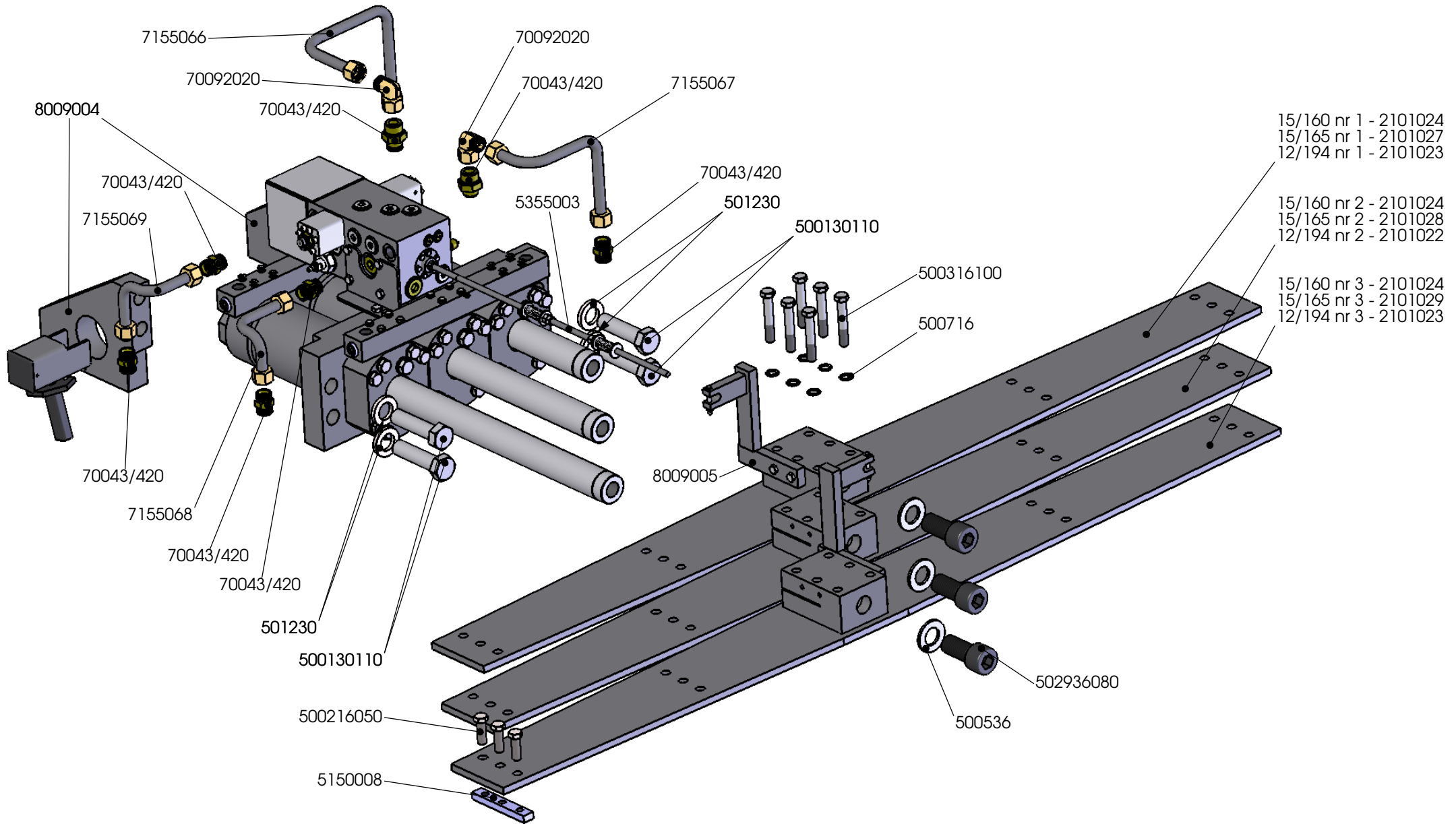

Cargo Floor B.V.  
 Byte 14  
 NL-7741 MK Coevorden  
 Phone : +31-524-593900  
 Fax : +31-524-593999  
 E-mail : info@cargo-floor.com

Project: **EXPLODED VIEWS CF3LP-2**

Subject: **Cylinder, piping, cross members, braces**

Date: 19-12-2013

Drawn: SK

Drw. nr.:

EV50002-LP-202

A3

This drawing and the information contained herein is for general presentation purposes only. This drawing is not intended for use on engineering plans and can be used as "as-is". This drawing is the property of Cargo Floor B.V. and must not be copied or reproduced without their written authority.

ART. NR. ART. Nº:	CILINDERS, LEIDINGEN, FRAMEVOETEN EN STEUNEN PAGINA 2 BENAMING	CILINDROS, TUBOS, MEMBRO CRUZADO, SUPORTE DE MONTAGEM PÁGINA 2 DESCRIÇÃO	PRIJS PREÇO
501230	Veerring M30 elvz	Arruela de mola CF3-LP M30 elvz Suporte	
500536	Sluistring M36 elvz (vlak)	Arruela plana M36 revestida a zinco	
500716	Borgring M16 (Nord-lock)	Arruela à prova de vibração M16 (Nord-lock)	
2101022	Framevoet CF3LP-2 nr. 2 (12/194)	Membro cruzado móvel CF3LP-2 no. 2 (12/194)	
2101023	Framevoet CF3LP-2 nr. 1/3 (12/194)	Membro cruzado móvel CF3LP-2 no. 1/3 (12/194)	
2101024	Framevoet CF3LP-2 nr. 1/2/3 (15/160) verzinkt	Membro cruzado móvel CF3LP-2 no. 1/2/3 (15/160), galvanizado	
2101027	Framevoet CF3LP-2 nr. 1 (15/165)	Membro cruzado móvel CF3LP-2 no. 1 (15/165)	
2101028	Framevoet CF3LP-2 nr. 2 (15/165)	Membro cruzado móvel CF3LP-2 no. 2 (15/165)	
2101029	Framevoet CF3LP-2 nr. 3 (15/165)	Membro cruzado móvel CF3LP-2 no. 3 (15/165)	
5150008	Montagestrip CF3 LP (3 x M16 L=150 mm)	Tira de montagem CF3 LP(3 x M16 L=150 mm)	
5355003	Draadstang compleet (1000 mm.)	Haste roscada completa (1000 mm)	
7155066	Hydraulische leiding nr. 1 (besturingsventiel 02/CF3LP-2)	Tubo hidráulico nº 1 (válvula de controlo 02/CF3LP-2)	
7155067	Hydraulische leiding nr. 2 (besturingsventiel 02/CF3LP-2)	Tubo hidráulico nº 2 (válvula de controlo 02/CF3LP-2)	
7155068	Hydraulische leiding nr. 3 (besturingsventiel 02/CF3LP-2)	Tubo hidráulico nº 3 (válvula de controlo 02/CF3LP-2)	
7155069	Hydraulische leiding nr. 4 (besturingsventiel 02/CF3LP-2)	Tubo hidráulico nº 4 (válvula de controlo 02/CF3LP-2)	
8009004	Lassteun CF3LP-2	Suporte de soldar CF3LP-2	
70092020	Stelbare haakse koppeling 20 x 20 mm.	Acoplamento quadrado regular 20 x 20 mm.	
500130110	Zeskantbout M30x110	Parafuso hexagonal M30x110	
500216050	Zeskanttapbout M16x50 elvz	Parafuso de cabeça hexagonal M16 x 50 revestido a zinco	
500316100	Zeskanttapbout M16x100 zwart (10.9)	Parafuso hexagonal para máquina M16x100 preto (10,9)	
502936080	Inbusbout M36x80	Parafuso sextavado M36x80	
70043/420	Rechte inschroefkoppeling 3/4" x 20 mm.	Acoplamento reto para aparafusar 3/4" x 20 mm	
	<p>Prijzen: per stuk in EURO, excl. B.T.W.</p> <p>Levering: af werk, volgens onze standaard leverings- en betalingsvoorwaarden</p> <p>Betaling: netto, binnen 14 dagen na factuurdatum</p> <p>Wijzigingen voorbehouden.</p>	<p>Preços: unitário em EUROS, IVA não incluído</p> <p>Entrega: Ex Works, de acordo com os nossos termos de pagamento e entrega habituais</p> <p>Pagamento: líquido, vencimento a 14 dias a contar da data da fatura</p> <p>Reservados todos os direitos</p>	

 +31 524 593 900

 info@cargofloor.com

[www.cargofloor.com](http://www.cargofloor.com)

FLOOR PROFILE

10/133 Leak Proof Deckslat HD (Heavy Duty)  
 Artikelnr. : 89.3497

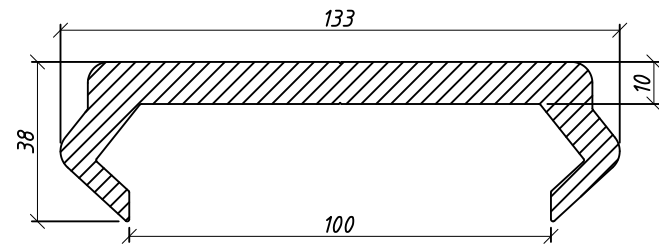

7/133 Leak Proof Deckslat Standaard  
 Artikelnr. : 891.4460

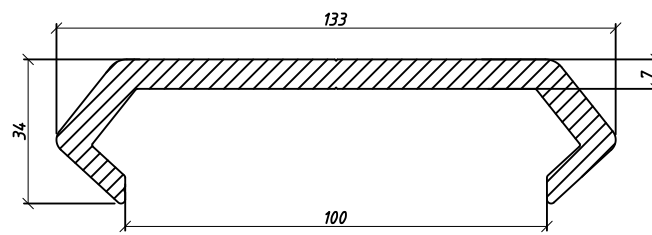

6/155 Leak Proof Deckslat smooth (refrigerated trailer)  
 Artikelnr. : 84.6149

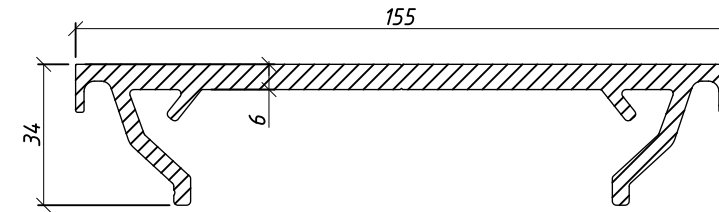

6/160 Leak Proof Deckslat SEALED  
 Artikelnr. : 86.6313

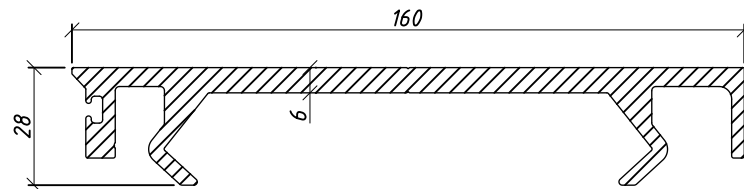

6/160 Leak Proof Gutter sealprofile  
 Left L=250mm Artikelnr. : 5448011  
 Right L=250mm Artikelnr. : 5448012

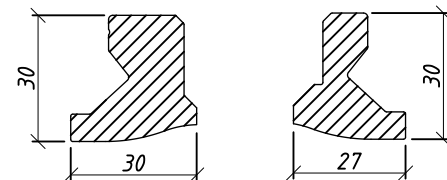

8-20/160 Leak Proof Deckslat HD-SEALED  
 Artikelnr. : 862.7825

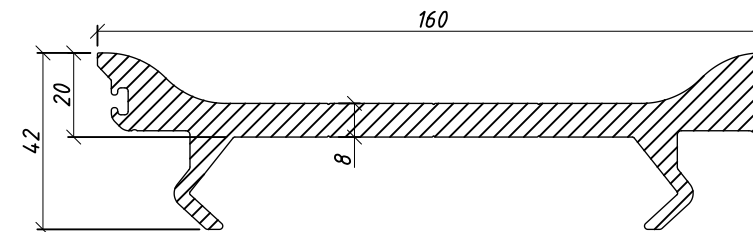

8-20/160 Leak Proof Gutter side-sealprofile  
 Artikelnr. : 5448013 (L=250mm)

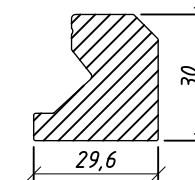

Plastic glider bearing T-subdeck LP  
 Artikelnr. : 4107022.01 and 4107022.02

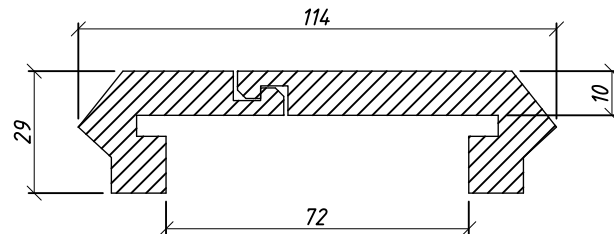

Plastic glider bearing T-subdeck LP with finger-opening  
 Artikelnr. : 4107045

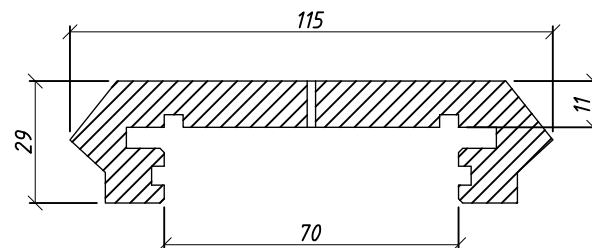

Aluminium endstop T-subdeck LP floor  
 Artikelnr. : 5448006  
 L=350mm

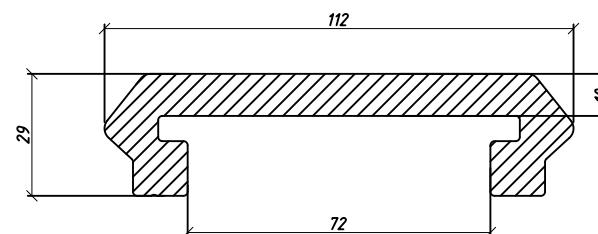

T-SUBDECK PROFILES

Alu 8/160 Leak Proof T subdeck (Slide-in)  
 Artikelnr. : 871.5177

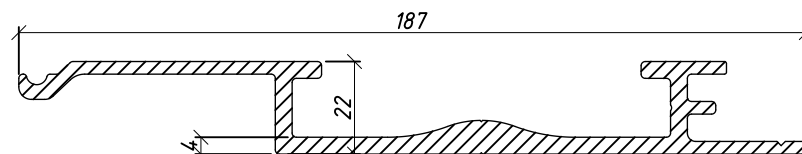

(SLIDE-IN)

Alu 8/160 Leak Proof T subdeck (Turn-in)  
 Artikelnr. : 871.4327

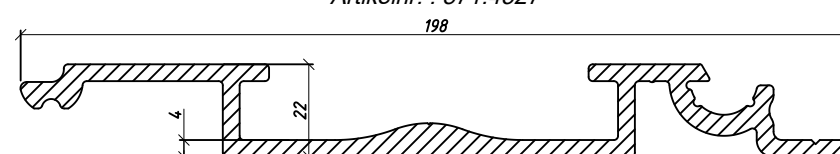

(TURN-IN)

Alu 4/160, LR/LP, T-subdeck plane gutter area (slide-in)  
 Artikelnr. : 862.7827

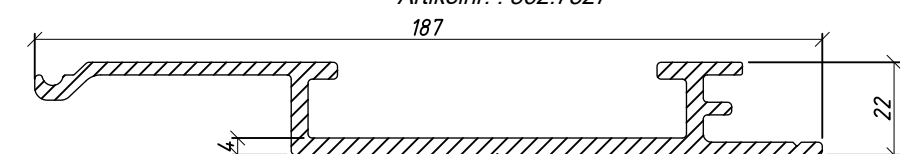

(SLIDE-IN)



Cargo Floor B.V.  
 Byte 14  
 NL-7741 MK Coevorden  
 Phone : +31-524-593900  
 E-mail : info@cargofloor.com



PROJECT:  
**Exploded views CF3LP**  
 SUBJECT:  
**Overview Floor**

All rights strictly reserved. Reproductions or issue to third parties in any form whatever is not permitted without written authority from the proprietor.

ORDER: ---  
 DATE: 20-07-06  
 DRAWN: Braakman

F	25-02-19	Diverse toevoegingen	ES
E	21-02-18	T-solid glider update	ES
D	24-01-14	Art.nr + maataanduiding	SK
C	17-01-14	Arcering + tekst	MP
B	16-12-13	Profielen aanpassen	SK
A	18-08-10	Profielen aanpassen	HZ
REV	DATE	CHANGES	BY

PAGE  
**3**  
 DRAWING NUMBER :  
**EV3LP001-CF-223**

ART. NR. ART. Nº:	VLOERDELEN PAGINA 3 BENAMING	PERFILS PÁGINA 3 DESCRIÇÃO	PRIJS PREÇO
84.6149	Alu profiel 6/155mm glad koeltrailer	Perfil alu. 6/155mm liso para carreta refrigerada	
86.6313	Alu. vloerprofiel "deckslat", LR/LP-serie, 6/160 SEALED	Perfil pavimento alu. "placa", série LR/LP, 6/160 SEALED	
89.3497	Alu 10/133mm Leak Proof deckslat HD(heavy duty)	Plataforma alu. 10/133mm à prova de fuga HD (Heavy Duty)	
4107045	Kunststof geprofileerd massief afdichtingsprofiel voor T-subdeck (locatie montagevinger), LR-series. opm. altijd per vloerprofiel 2 stuks nodig welke zijdelings in elkaar schuiven L=760mm.	Perfil de vedante plástico sólido para subcobertura T (localizado no dedo de montagem), série LR, cada placa requer 2 peças que deslizam de lado em relação uma à outra L=760mm.	
5448006	Aluminium eindstop T-subdeck LP vloer (350 mm)	Trava de alumínio subplaca T pavimento LP (350 mm)	
5448011	Alu. goot afsluitprofiel links t.b.v. "deckslat" SEALED (L=250mm)	Perfil de paragem de calha em alumínio direito para "longarinas" VEDADO (C=250 mm)	
5448012	Alu. goot afsluitprofiel rechts t.b.v. "deckslat" SEALED (L=250 mm)	Perfil de paragem de calha em alumínio direito para "longarinas" VEDADO (C=250 mm)	
5448013	Alu zijprofiel voor LR/LP-serie, 8-20/160 mm HD sealed (L.= 250 mm)	Perfil lateral em alumínio para série LR/LP, 8-20 160 mm vedante HD (C= 250 mm)	
862.7825	Alu 8-20/160mm deckslat HD SEALED voor LR/LP-series	Alu 8-20/160mm deckslat HD SEALED para LR/LP-series	
862.7827	Alu LIGHTWEIGHT T-subdeck 4/160mm (slide-in) plane gutter area, alleen voor SEALED LR/LP series	Alu LIGHTWEIGHT T-subdeck 4/160mm (slide-in) plane gutter area, apenas para SEALED LR/LP series	
871.4327	Alu 8/160mm Leak Proof T subdeck (Turn-in)	Alu 8/160mm subplaca T à prova de água (Turn-in)	
871.5177	Alu 8/160mm Leak Proof T subdeck (Slide-in) voor alu/staal	Alu 8/160mm à prova de água T subplaca (deslizante) para alu./aço	
891.4460	Alu 7/133mm Leak Proof deckslat standaard	Plataforma alu. 7/133mm à prova de fuga standard	
4107022.01	Kunststof geleidingsprofiel massief, ½ deel type A behorend bij deel B, LP/LR serie (Alu 133 LP,T-groef 84 mm.) l=2000 mm. Standaard	Faixa de rolamento de plástico sólida, ½ peça do tipo A pertencente à peça B, série LP/LR (alu 133 LP, ranhura em T de 84 mm), l=2000 mm padrão	
4107022.02	Kunststof geleidingsprofiel massief, ½ deel type B behorend bij deel A, LP/LR serie (Alu 133 LP,T-groef 84 mm.) l=2000 mm. Standaard	Faixa de rolamento de plástico sólida, ½ peça do tipo B pertencente à peça A, série LP/LR (alu 133 LP, ranhura em T de 84 mm), l=2000 mm padrão	
	<p>Prijzen: per stuk in EURO, excl. B.T.W.</p> <p>Levering: af werk, volgens onze standaard leverings- en betalingsvoorwaarden</p> <p>Betaling: netto, binnen 14 dagen na factuurdatum</p> <p>Wijzigingen voorbehouden.</p>	<p>Preços: unitário em EUROS, IVA não incluído</p> <p>Entrega: Ex Works, de acordo com os nossos termos de pagamento e entrega habituais</p> <p>Pagamento: líquido, vencimento a 14 dias a contar da data da fatura</p> <p>Reservados todos os direitos</p>	

 +31 524 593 900

 info@cargofloor.com

[www.cargofloor.com](http://www.cargofloor.com)