

FOR INFORMATION ONLY !

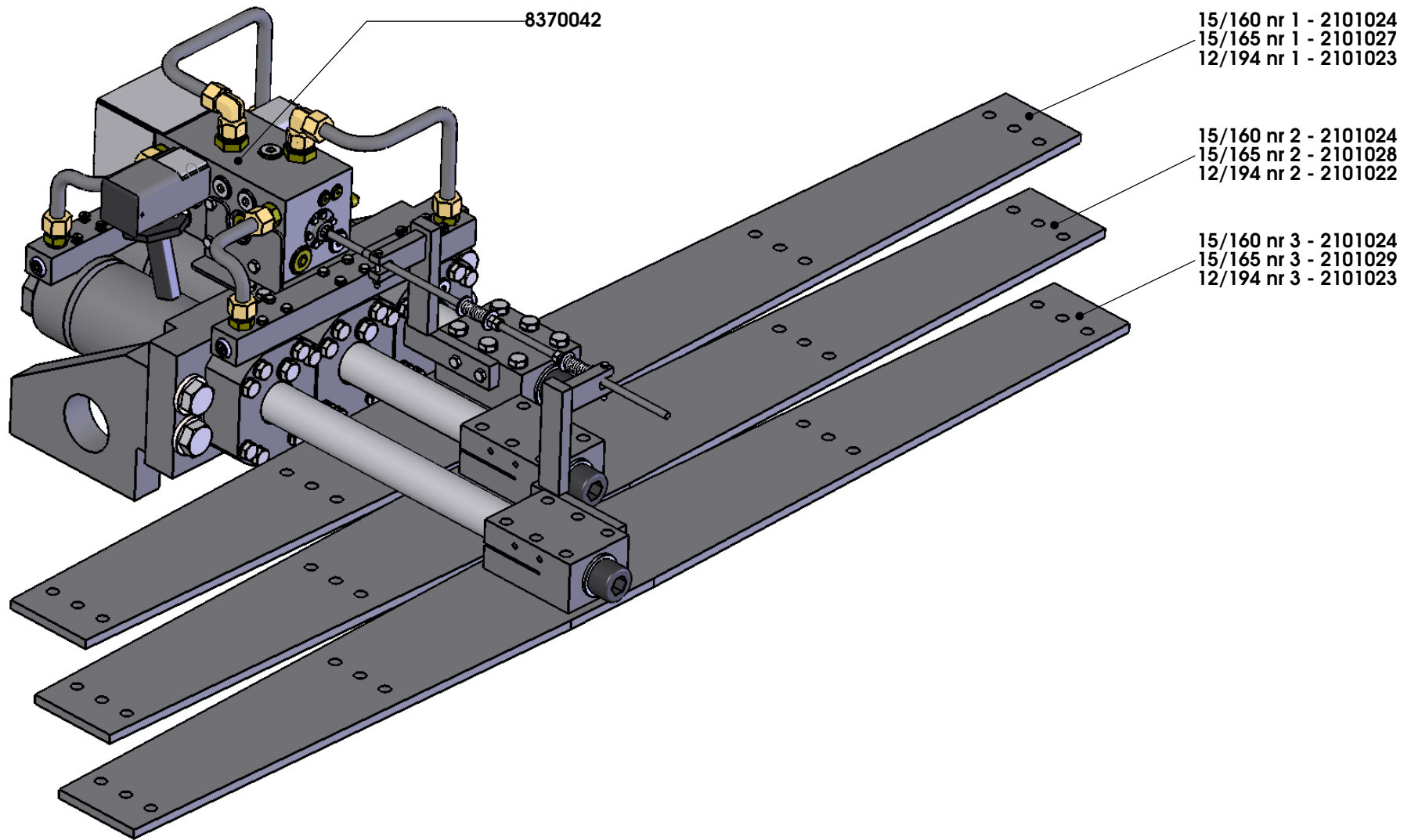

Cargo Floor B.V.
Byte 14
NL-7741 MK Coevorden
Phone : +31-524-593900
Fax : +31-524-593999
E-mail : info@cargo-floor.com

Project: **EXPLODED VIEWS CF3LP-2**

Subject: **Drive unit**

Date: 19-12-2013

Drawn: SK

Drw. nr.: **EV50002-LP-200**

A3

This drawing and the information contained herein is for general presentation purposes only.
This drawing is not intended for use on engineering plans and can be used as "as-is".
This drawing is the property of Cargo Floor B.V. and must not be copied or reproduced without their written authority.

Page 1

ART. NR. NUMÉRO DE PIÈCE	AANDRIJFUNIT PAGINA 1 BENAMING	LES UNITÉS MOTRICES PAGE 1 DESIGNATION	PRIJS PRIX
2101022	Framevoet CF3LP-2 nr. 2 (12/194)	Tube poussoir CF3LP-2 no. 2 (12/194)	
2101023	Framevoet CF3LP-2 nr. 1/3 (12/194)	Tube poussoir CF3LP-2 no. 1/3 (12/194)	
2101024	Framevoet CF3LP-2 nr. 1/2/3 (15/160) verzinkt	Tube poussoir CF3LP-2 no. 1/2/3 (15/160), galvanisé	
2101027	Framevoet CF3LP-2 nr. 1 (15/165)	Tube poussoir CF3LP-2 no. 1 (15/165)	
2101028	Framevoet CF3LP-2 nr. 2 (15/165)	Tube poussoir CF3LP-2 no. 2 (15/165)	
2101029	Framevoet CF3LP-2 nr. 3 (15/165)	Tube poussoir CF3LP-2 no. 3 (15/165)	
8370042	Besturingsventiel 02 B-bediend (compleet)	Bloc de commande 02 "B" (complet)	
<p>Prijzen: per stuk in EURO, excl. B.T.W.</p> <p>Levering: af werk, volgens onze standaard leverings- en betalingsvoorwaarden</p> <p>Betaling: netto, binnen 14 dagen na factuurdatum</p> <p>Wijzigingen voorbehouden.</p>		<p>Prix: unitaires en EUROS, hors T.V.A.</p> <p>Livraison: départ usine, selon notre standard conditions de livraison et de paiement</p> <p>Paiement: 14 jours nets date de facture</p> <p>Sous réserve de modifications</p>	

 +31 524 593 900

 info@cargofloor.com

www.cargofloor.com

FOR INFORMATION ONLY !

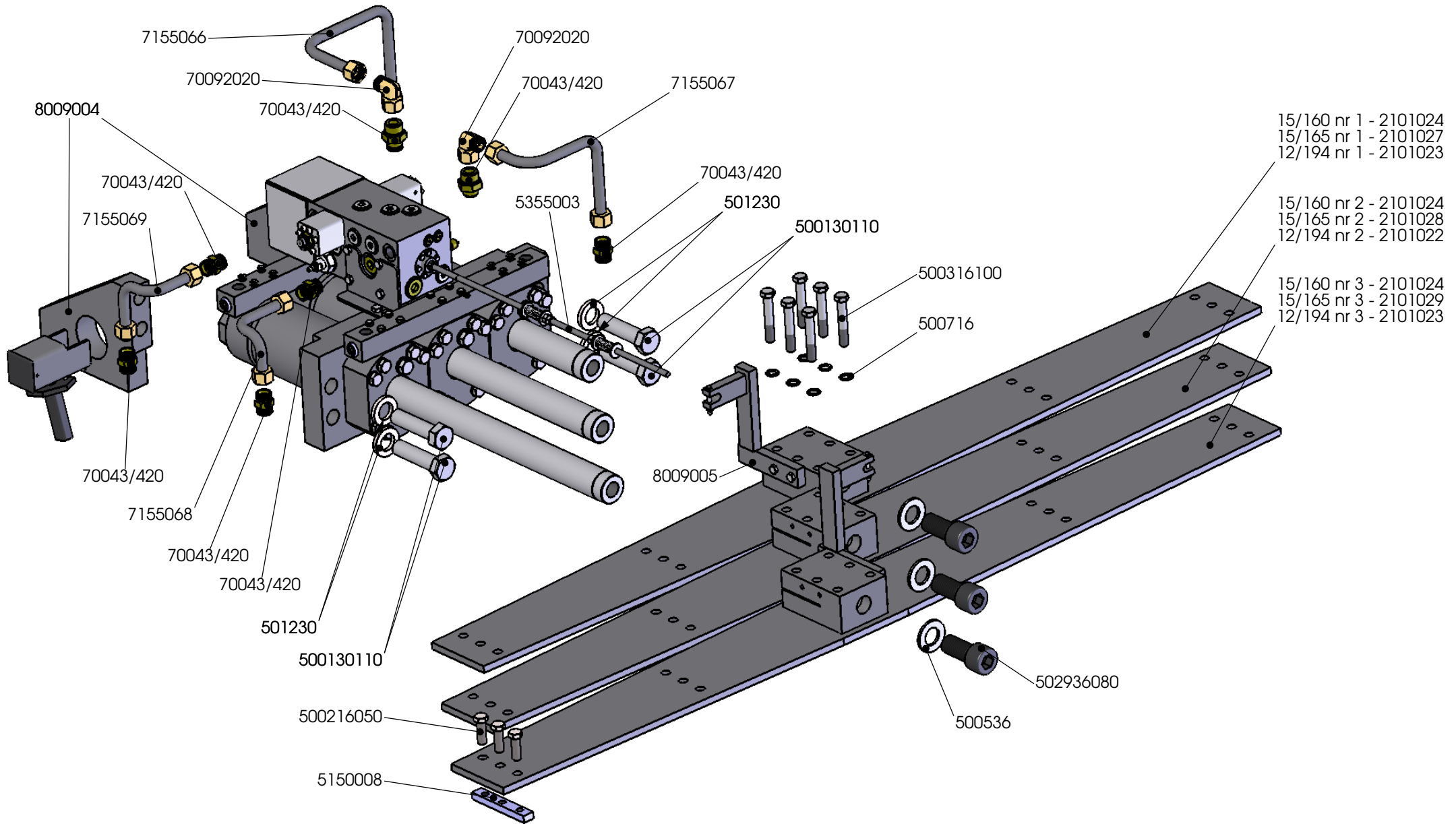

Cargo Floor B.V.
 Byte 14
 NL-7741 MK Coevorden
 Phone : +31-524-593900
 Fax : +31-524-593999
 E-mail : info@cargo-floor.com

Project: **EXPLODED VIEWS CF3LP-2**

Subject: **Cylinder, piping, cross members, braces**

Date: 19-12-2013

Drawn: SK

Drw. nr.: **EV50002-LP-202**

A3

This drawing and the information contained herein is for general presentation purposes only. This drawing is not intended for use on engineering plans and can be used as "as-is". This drawing is the property of Cargo Floor B.V. and must not be copied or reproduced without their written authority.

ART. NR. NUMÉRO DE PIÈCE	CILINDERS, LEIDINGEN, FRAMEVOETEN EN STEUNEN PAGINA 2 BENAMING	VERIN, TUBE, POUSSOIR, SUPPORT DE FIXATION PAGE 2 DESIGNATION	PRIJS PRIX
501230	Veerring M30 elvz	CF3-LP Rondelle ressort M30 elvz	
500536	Sluistring M36 elvz (vlak)	Rondelle plat M36 plaquée zinc	
500716	Borgring M16 (Nord-lock)	Rondelle anti vibration M16 (Nord-lock)	
2101022	Framevoet CF3LP-2 nr. 2 (12/194)	Tube poussoir CF3LP-2 no. 2 (12/194)	
2101023	Framevoet CF3LP-2 nr. 1/3 (12/194)	Tube poussoir CF3LP-2 no. 1/3 (12/194)	
2101024	Framevoet CF3LP-2 nr. 1/2/3 (15/160) verzinkt	Tube poussoir CF3LP-2 no. 1/2/3 (15/160), galvanisé	
2101027	Framevoet CF3LP-2 nr. 1 (15/165)	Tube poussoir CF3LP-2 no. 1 (15/165)	
2101028	Framevoet CF3LP-2 nr. 2 (15/165)	Tube poussoir CF3LP-2 no. 2 (15/165)	
2101029	Framevoet CF3LP-2 nr. 3 (15/165)	Tube poussoir CF3LP-2 no. 3 (15/165)	
5150008	Montagestrip CF3 LP (3 x M16 L=150 mm)	Bande de montage CF3 LP (3 x M16 L=150 mm)	
5355003	Draadstang compleet (1000 mm.)	Tige filetée complètement (1000 mm. [39.4"])	
7155066	Hydraulische leiding nr. 1 (besturingsventiel 02/CF3LP-2)	Tube hydraulique n° 1 (bloc de commande 02/CF3LP-2)	
7155067	Hydraulische leiding nr. 2 (besturingsventiel 02/CF3LP-2)	Tube hydraulique n° 2 (bloc de commande 02/CF3LP-2)	
7155068	Hydraulische leiding nr. 3 (besturingsventiel 02/CF3LP-2)	Tube hydraulique n° 3 (bloc de commande 02/CF3LP-2)	
7155069	Hydraulische leiding nr. 4 (besturingsventiel 02/CF3LP-2)	Tube hydraulique n° 4 (bloc de commande 02/CF3LP-2)	
8009004	Lassteun CF3LP-2	Soudure Soutien CF3LP-2	
70092020	Stelbare haakse koppeling 20 x 20 mm.	Accouplement carré de contrôle 20 x 20 mm.	
500130110	Zeskantbout M30x110	Boulon hexagonal M30x110	
500216050	Zeskanttapbout M16x50 elvz	Vis à tête hexagonale contrepercée M16 x 50 plaquée zinc	
500316100	Zeskanttapbout M16x100 zwart (10.9)	Boulon à tête hexagonale M16x100 noir (10,9)	
502936080	Inbusbout M36x80	Vis à tête cylindrique M36x80	
70043/420	Rechte inschroefkoppeling 3/4" x 20 mm.	Raccord droit 3/4" x 20 mm.	
<p>Prijzen: per stuk in EURO, excl. B.T.W.</p> <p>Levering: af werk, volgens onze standaard leverings- en betalingsvoorwaarden</p> <p>Betaling: netto, binnen 14 dagen na factuurdatum</p> <p>Wijzigingen voorbehouden.</p>		<p>Prix: unitaires en EUROS, hors T.V.A.</p> <p>Livraison: départ usine, selon notre standard conditions de livraison et de paiement</p> <p>Paiement: 14 jours nets date de facture</p> <p>Sous réserve de modifications</p>	

 +31 524 593 900

 info@cargofloor.com

www.cargofloor.com

FLOOR PROFILE

10/133 Leak Proof Deckslat HD (Heavy Duty)
 Artikelnr. : 89.3497

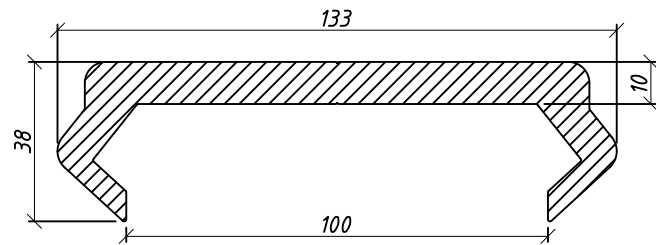

7/133 Leak Proof Deckslat Standaard
 Artikelnr. : 891.4460

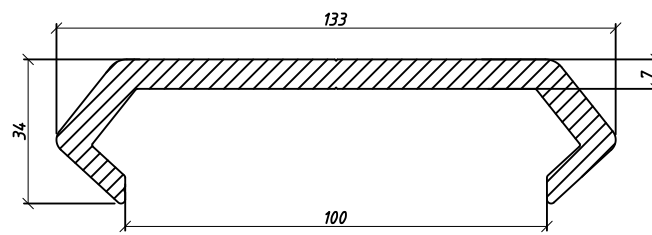

6/155 Leak Proof Deckslat smooth (refrigerated trailer)
 Artikelnr. : 84.6149

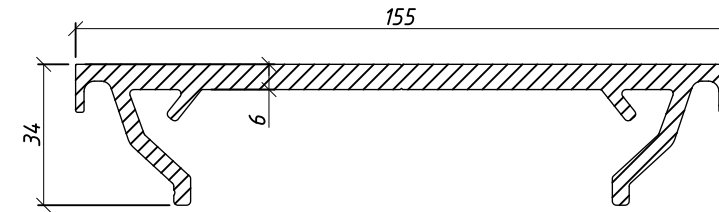

6/160 Leak Proof Deckslat SEALED
 Artikelnr. : 86.6313

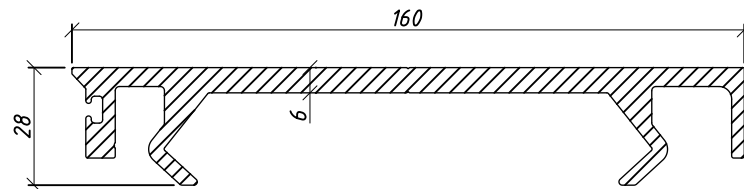

6/160 Leak Proof Gutter sealprofile
 Left L=250mm Artikelnr. : 5448011
 Right L=250mm Artikelnr. : 5448012

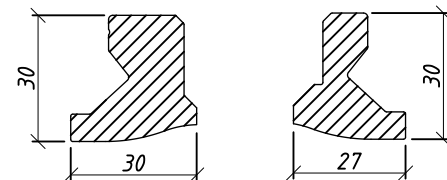

8-20/160 Leak Proof Deckslat HD-SEALED
 Artikelnr. : 862.7825

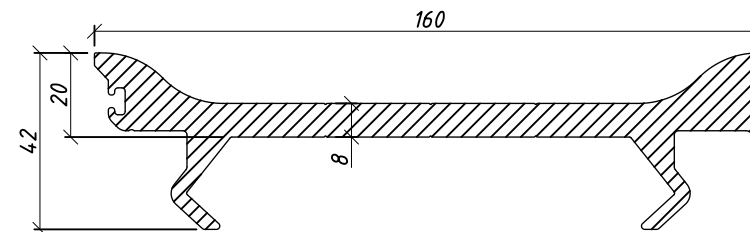

8-20/160 Leak Proof Gutter side-sealprofile
 Artikelnr. : 5448013 (L=250mm)

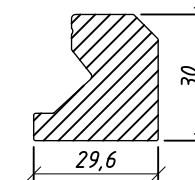

Plastic glider bearing T-subdeck LP
 Artikelnr. : 4107022.01 and 4107022.02

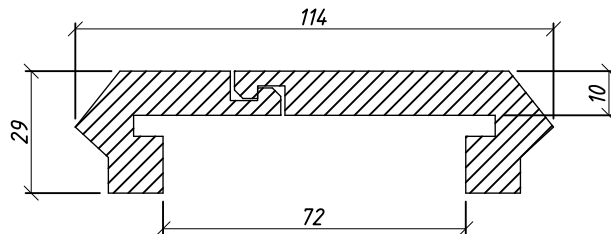

Plastic glider bearing T-subdeck LP with finger-opening
 Artikelnr. : 4107045

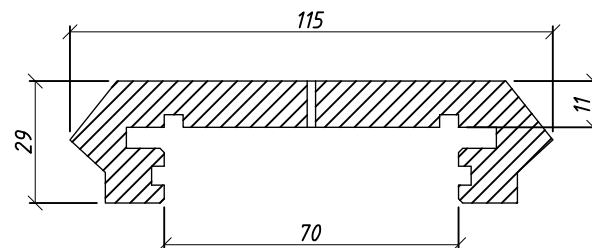

Aluminium endstop T-subdeck LP floor
 Artikelnr. : 5448006
 L=350mm

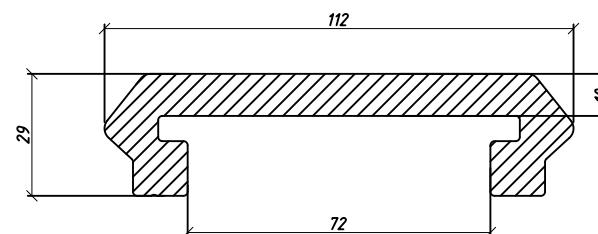

T-SUBDECK PROFILES

Alu 8/160 Leak Proof T subdeck (Slide-in)
 Artikelnr. : 871.5177

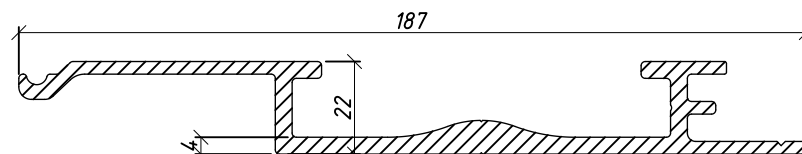

(SLIDE-IN)

Alu 8/160 Leak Proof T subdeck (Turn-in)
 Artikelnr. : 871.4327

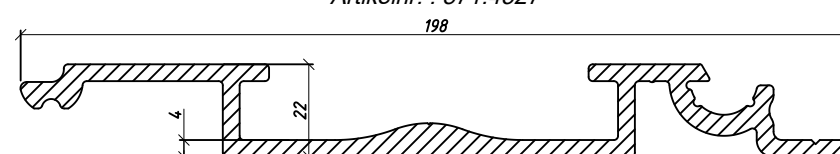

(TURN-IN)

Alu 4/160, LR/LP, T-subdeck plane gutter area (slide-in)
 Artikelnr. : 862.7827

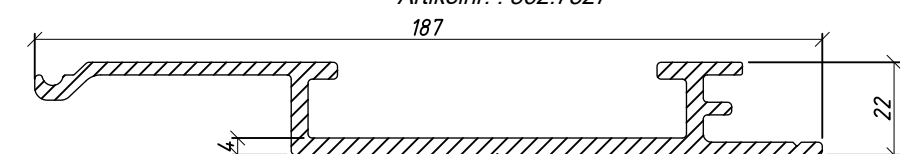

(SLIDE-IN)



Cargo Floor B.V.
 Byte 14
 NL-7741 MK Coevorden
 Phone : +31-524-593900
 E-mail : info@cargofloor.com



PROJECT:
Exploded views CF3LP
 SUBJECT:
Overview Floor

All rights strictly reserved. Reproductions or issue to third parties in any form whatever is not permitted without written authority from the proprietor.

ORDER: ---
 DATE: 20-07-06
 DRAWN: Braakman

F	25-02-19	Diverse toevoegingen	ES
E	21-02-18	T-solid glider update	ES
D	24-01-14	Art.nr + maataanduiding	SK
C	17-01-14	Arcering + tekst	MP
B	16-12-13	Profielen aanpassen	SK
A	18-08-10	Profielen aanpassen	HZ
REV	DATE	CHANGES	BY

PAGE
3
 DRAWING NUMBER :
EV3LP001-CF-223

ART. NR. NUMÉRO DE PIÈCE	VLOERDELEN PAGINA 3 BENAMING	PROFILS PAGE 3 DESIGNATION	PRIJS PRIX
84.6149	Alu profiel 6/155mm glad koeltrailer	Alu profil 6/155mm lisse pour remorque réfrigérée	
86.6313	Alu. vloerprofiel "deckslat", LR/LP-serie, 6/160 SEALED	Alu profil "deckslat", LR/LP series 6/160 SEALED	
89.3497	Alu 10/133mm Leak Proof deckslat HD(heavy duty)	Alu 10/133mm Profil Leak-Proof deckslat HD (Heavy Duty)	
4107045	Kunststof geprofileerd massief afdichtingsprofiel voor T-subdeck (locatie montagevinger), LR-series. opm. altijd per vloerprofiel 2 stuks nodig welke zijdelings in elkaar schuiven L=760mm.	Profilé solide en plastique profile d'étanchéité pour dessous de pont en T (se trouvant sur la patte de fixation), modèle LR. remarque, chaque latte a besoin de 2 exemplaires alors qui s'insèrent l'un dans l'autre latéralement, L=760mm	
5448006	Aluminium eindstop T-subdeck LP vloer (350 mm)	Fin de course en aluminium pour plancher LP T-subdeck (350 mm [13.78"])	
5448011	Alu. goot afsluitprofiel links t.b.v. "deckslat" SEALED (L=250mm)	Profilé d'obturation de gouttière alu droit pour « deckslat » ÉTANCHE (L=250 mm)	
5448012	Alu. goot afsluitprofiel rechts t.b.v. "deckslat" SEALED (L=250 mm)	Profilé d'obturation de gouttière alu droit pour « deckslat » ÉTANCHE (L=250 mm)	
5448013	Alu zijprofiel voor LR/LP-serie, 8-20/160 mm HD sealed (L.= 250 mm)	Profilé latéral alu pour série LR/LP, 8-20 160 mm étanche HD (L.= 250 mm)	
862.7825	Alu 8-20/160mm deckslat HD SEALED voor LR/LP-series	Alu 8-20/160mm deckslat HD SEALED pour LR/LP-series	
862.7827	Alu LIGHTWEIGHT T-subdeck 4/160mm (slide-in) plane gutter area, alleen voor SEALED LR/LP series	Alu LIGHTWEIGHT T-subdeck 4/160mm (slide-in) plane gutter area, seulement pour SEALED LR/LP series	
871.4327	Alu 8/160mm Leak Proof T subdeck (Turn-in)	Alu 8/160mm Leak Proof T subdeck (Turn-in)	
871.5177	Alu 8/160mm Leak Proof T subdeck (Slide-in) voor alu/staal	Alu 8/160mm Leak Proof T subdeck (Slide-in)	
891.4460	Alu 7/133mm Leak Proof deckslat standaard	Alu 7/133mm Leak Proof deckslat standard	
4107022.01	Kunststof geleidingsprofiel massief, ½ deel type A behorend bij deel B, LP/LR serie (Alu 133 LP,T-groef 84 mm.) l=2000 mm. Standaard	Palier en plastique massif, ½ pièce type A correspondant à la pièce B, série LP/LR (alu 133 LP, rainure T 84 mm), l=2000 mm standard	
4107022.02	Kunststof geleidingsprofiel massief, ½ deel type B behorend bij deel A, LP/LR serie (Alu 133 LP,T-groef 84 mm.) l=2000 mm. Standaard	Palier en plastique massif, ½ pièce type B correspondant à la pièce A, série LP/LR (alu 133 LP, rainure T 84 mm), l=2000 mm standard	
<p>Prijzen: per stuk in EURO, excl. B.T.W.</p> <p>Levering: af werk, volgens onze standaard leverings- en betalingsvoorwaarden</p> <p>Betaling: netto, binnen 14 dagen na factuurdatum</p> <p>Wijzigingen voorbehouden.</p>		<p>Prix: unitaires en EUROS, hors T.V.A.</p> <p>Livraison: départ usine, selon notre standard conditions de livraison et de paiement</p> <p>Paiement: 14 jours nets date de facture</p> <p>Sous réserve de modifications</p>	

 +31 524 593 900

 info@cargofloor.com

www.cargofloor.com