

## **CARGO FLOOR INSTRUCTIONS FOR USE**

We would like to introduce to you the right operation of our Cargo Floor system with the help of the following data and we also want to point out to you the steps that you can take to solve malfunctions. Please read and follow our instructions carefully so that the Cargo Floor system will give you reliable and trouble free service for many years.

If the Cargo Floor system does not operate at all (or properly) after following the instructions, please do not hesitate to contact your nearest agent, who will with no doubt assist you in solving the problem.

Please pay particular attention to the contents of the “WARNINGS” and “IMPORTANT INSTRUCTIONS” sections on pages 2 & 3!

-	Warnings	page	2
-	Important instructions	page	3
-	Identification tag	page	4
-	Stickers, “E”-control	page	5
-	Function of “E”-control switches	page	6
-	Electrical circuit diagram “E”-control	page	8
-	Control valve “E”-control	page	8
-	Hydraulic circuit diagram “E”-control	page	9
-	Stickers “B”-control	page	10
-	Function of “B”-control switches	page	11
-	Electrical circuit diagram “B”-control	page	13
-	Control valve “B”-control	page	13
-	Hydraulic circuit diagram “B”-control	page	14
-	Function of “A”-control switches	page	15
-	Control valve “A”-control	page	15
-	Hydraulic circuit diagram “A”-control	page	16
-	Technical specifications CF500 SL, CF100 SLL & CF 3LP	page	17
-	Pump specifications	page	19
-	Emergency control	page	20
-	Adjusting the control valve	page	21
-	Maintenance instructions	page	22
-	Malfunctions	page	23
-	Guarantee conditions	page	25
-	Drawing of the Cargo Floor CF3-LP 15/160 system	page	26
-	Profiles types	page	27
-	Attachment of floor profiles, seals and end caps	page	28

## WARNINGS

- The Cargo Floor system may not be operated, if there is no user manual present in the local language of the original owner of the Cargo Floor system;
- Moving parts must be shielded!
- Verify that the floor moves in the correct loading and unloading directions before using the system.
- All persons must remain at a distance of at least 10 metres whilst the Cargo Floor is in operation
- After use the system must always be returned to the non-energized “0” position
- The pump and electrical installation must always be switched-off when working on the system; in addition, the hoses and/or pipelines between the pump and the Cargo Floor should also be disconnected.
- Check the oil level after when the work on the system is done.
- **Guarantee** shall only be given with the prior consent of Cargo Floor B.V.! With guarantee always state the system number with all correspondence. You can report a request for guarantee simply on our website: [www.cargofloor.nl/download/download\\_cf500sl.html](http://www.cargofloor.nl/download/download_cf500sl.html);

In the event of an EMERGENCY, operation of the Cargo Floor system can be halted as follows:

- ◆ By pressing the stop buttons on the remote control;
- ◆ By turning all switches to position “0”;
- ◆ Turning off the pump;
- ◆ Turning off the main switch of the power supply;
- ◆ Turning off the motor of the electro-hydraulic aggregate;

The WARNING STICKER is attached to the outside of the control cabinet. See page 4

<p><b>NL</b></p> 	<p><b>Belangrijke aanwijzing voordat het Cargo Floor-systeem in gebruik mag worden genomen:</b></p> <ul style="list-style-type: none"><li>- altijd eerst de bedieningshandleiding raadplegen.</li><li>- altijd eerst de gewenste transport richting bepalen en controleren.</li><li>- Personen moeten altijd tenminste 10 meter afstand houden van een werkend Cargo Floor systeem.</li><li>- Na gebruik altijd het Cargo Floor systeem in de niet geactiveerde neutrale (0) posities terugzetten</li><li>- Bij <b>onderhoudswerkzaamheden</b>; alles uitschakelen en de hydrauliek loskoppelen</li></ul>	<p><b>F</b></p> 	<p><b>Indications importantes avant de pouvoir utiliser le système Cargo Floor:</b></p> <ul style="list-style-type: none"><li>- Commencez toujours par consulter le manuel d'utilisation.</li><li>- Commencez toujours par déterminer et contrôler la direction de transport souhaitée.</li><li>- Tenez-vous toujours à au moins 10 mètres de distance d'un système Cargo Floor en fonctionnement.</li><li>- Après utilisation, remettez toujours le système Cargo Floor en position neutre (0) non activée</li><li>- Pour <b>tous travaux de maintenance</b>, tout déconnecter et débrancher l'hydraulique</li></ul>
<p><b>D</b></p> 	<p><b>Wichtige Anweisung vor der Inbetriebnahme des Cargo Floor Systems:</b></p> <ul style="list-style-type: none"><li>- Immer erst die Bedienungsanleitung lesen.</li><li>- Zuerst immer die gewünschte Transportrichtung bestimmen und kontrollieren.</li><li>- Vom aktivierten Cargo Floor System müssen Personen mindestens 10 Meter Abstand halten.</li><li>- Nach dem Einsatz das Cargo Floor System in die nicht aktivierten, neutralen Null-Stellungen (0) zurücksetzen.</li><li>- Bei <b>Wartungsarbeiten</b>, alles ausschalten und die Hydraulik abkuppeln</li></ul>	<p><b>I</b></p> 	<p><b>Prima di mettere in funzione il sistema Cargo Floor, prendere nota delle seguenti indicazioni importanti:</b></p> <ul style="list-style-type: none"><li>- Consultare sempre prima il manuale operativo..</li><li>- Stabilire sempre prima la direzione di trasporto desiderata e controllare.</li><li>- Quando il sistema Cargo Floor è in funzione, le persone devono sempre mantenere una distanza di almeno 10 metri</li><li>- Dopo l'uso, riportare sempre il sistema Cargo Floor nella posizione neutra (0).</li><li>- In <b>caso di manutenzione</b>, spegnere il sistema e scollegare l'impianto idraulico</li></ul>
<p><b>GB</b></p> 	<p><b>Important tips before the Cargo Floor system can be put into operation:</b></p> <ul style="list-style-type: none"><li>- Always consult the operation manual first.</li><li>- Always determine and check the direction of transport.</li><li>- People must always maintain a distance of at least 10 metres from a working Cargo Floor system.</li><li>- After use, always switch the Cargo Floor system back to the non-activated neutral (0) position.</li><li>- By <b>maintenance work</b>, switch off everything and disconnect the Hydraulics.</li></ul>	<p><b>E</b></p> 	<p><b>Instrucciones importantes a seguir antes de poner en funcionamiento el sistema Cargo Floor:</b></p> <ul style="list-style-type: none"><li>- Siempre consulte primero el manual de instrucciones.</li><li>- Siempre determine y controle primero el sentido de transporte deseado.</li><li>- Cuide de que las personas siempre se mantengan a por lo menos 10 metros de distancia de un sistema Cargo Floor en movimiento.</li><li>- Una vez concluida la operación, siempre retorne el sistema Cargo Floor a las posiciones neutrales no activadas (0)</li><li>- Por <b>trabagos de mantenimiento</b>, apagar todo y desconectar los hidraulicos.</li></ul>
 <p><b>CARGO FLOOR®</b> HORIZONTAL LOADING / UNLOADING SYSTEM</p> <p>S.006</p>		 <p><a href="http://www.cargofloor.nl">www.cargofloor.nl</a></p>	

## **IMPORTANT INSTRUCTIONS**

- Avoid letting dirt get into the hydraulic system when disconnecting the connectors or when topping up the oil tank.
- Adjust the work speed when, for example, heavy massive products are being loaded or unloaded when using full power (see page 17), so as to avoid overloading.
- It is recommended that the maximum operational pressure not be exceeded (see page 17). It can happen when loading and unloading wet, heavy and massive materials, for example, that the maximum operational pressure is exceeded. It is then advisable to decrease the load slightly, for the benefit of the system lifetime.
- Avoid loading and unloading sharp objects such as glass. Such objects cause unnecessary wear of the seals. If the seals are worn they can easily be replaced. New seal strips are available at your system builder. (Article code 4008006, 300 mtr)  
If you want to transport such materials safely, then we advise you to use a protective roll-up cover mechanism.
- Never exceed the maximum number of strokes per minute when using the full stroke (see page 17). A greater number of strokes causes enormous forces in the system and chassis, and causes a lot of heat to be generated in the hydraulic system.
- When unloading a load, start the system slowly and gently, until the load comes free of the walls, then you can increase the speed.
- When loading and unloading pallets it is important that good, flat pallets are placed on the floor. If this is not the case there is the possibility that the pallets won't move. If necessary place a softwood plank multiplex (of about 300 x 18 x 2350 mm).
- Check the join between the 2 stationary floor profiles and the moving profiles. If there is play between these, then adjust the stationary profiles so that the join appears optimal and there is no leakage via the sidewalls.

Check the join between the aluminum floor profiles and the Cargo Floor-system. If there is play then either tighten the bolts or replace them.

Specifications of the screws:

M12 x 25 countersunk screws with hexagon socket, class 10.9, galvanized. DIN 7991

Loctite must be applied to the threaded surfaces of the bolts (Loctite® 243 cat. o. 23286 threadlocking).

A torque of 100 – 140 Nm should be used to tighten the bolts.

**IDENTIFICATION TAG**



**MEANINGS OF THE FIELDS:**

- TYPE** : System type
- SYST. NR.** : Serial number
- PROD. NR.** : Production number
- MAX. WP.** : Maximum wording
- MAX. CAP.** : Maximum workload
- PROD. YR.** : Production year

Positie typeplaatje CF500  
Position of Type plate CF500  
Position Typenschild CF500  
Position du plaque signalétique CF500

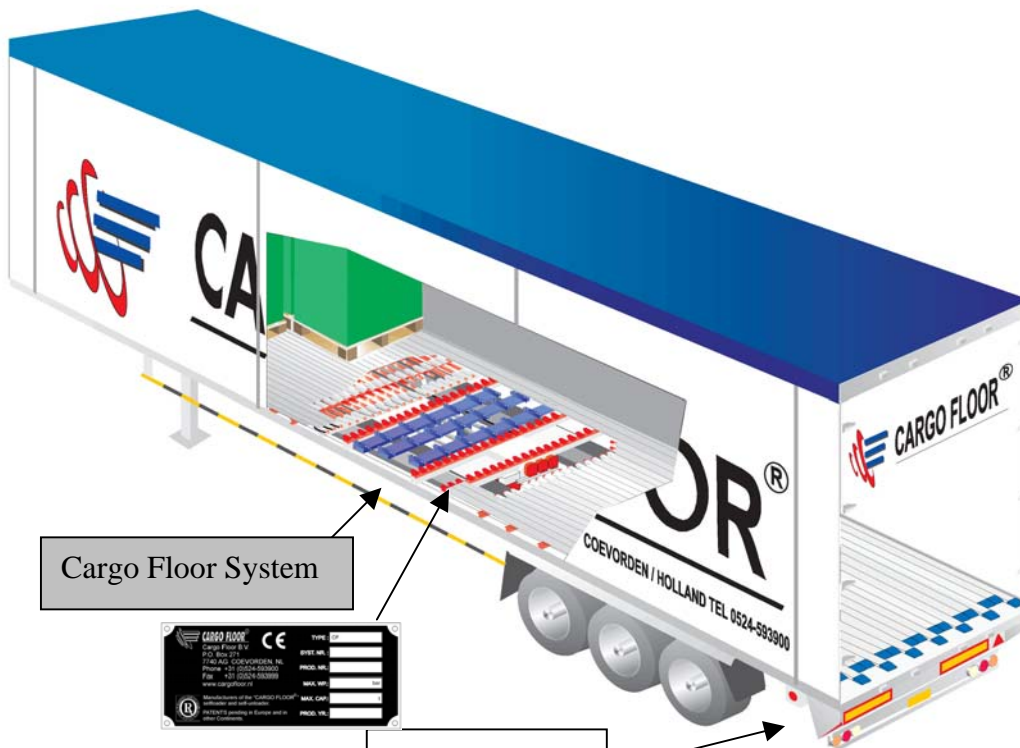
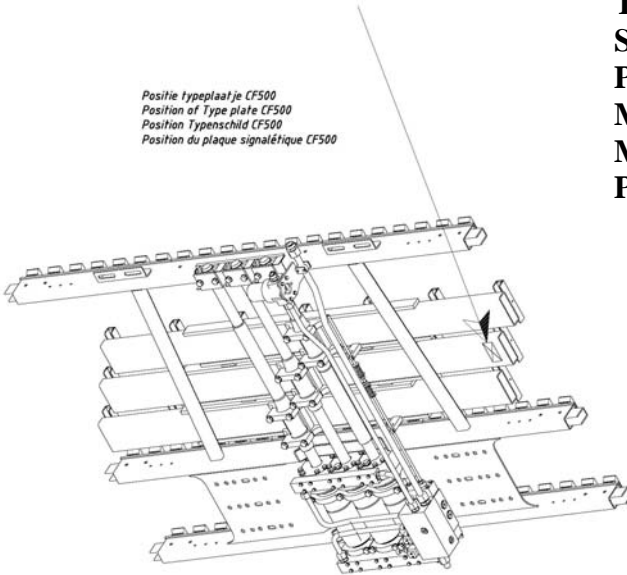

Cargo Floor System

Control cabinet

## STICKERS "E" -CONTROL

These stickers, which are delivered with the Cargo Floor systems, should be applied to the vehicle, in the neighbourhood of the described operation.

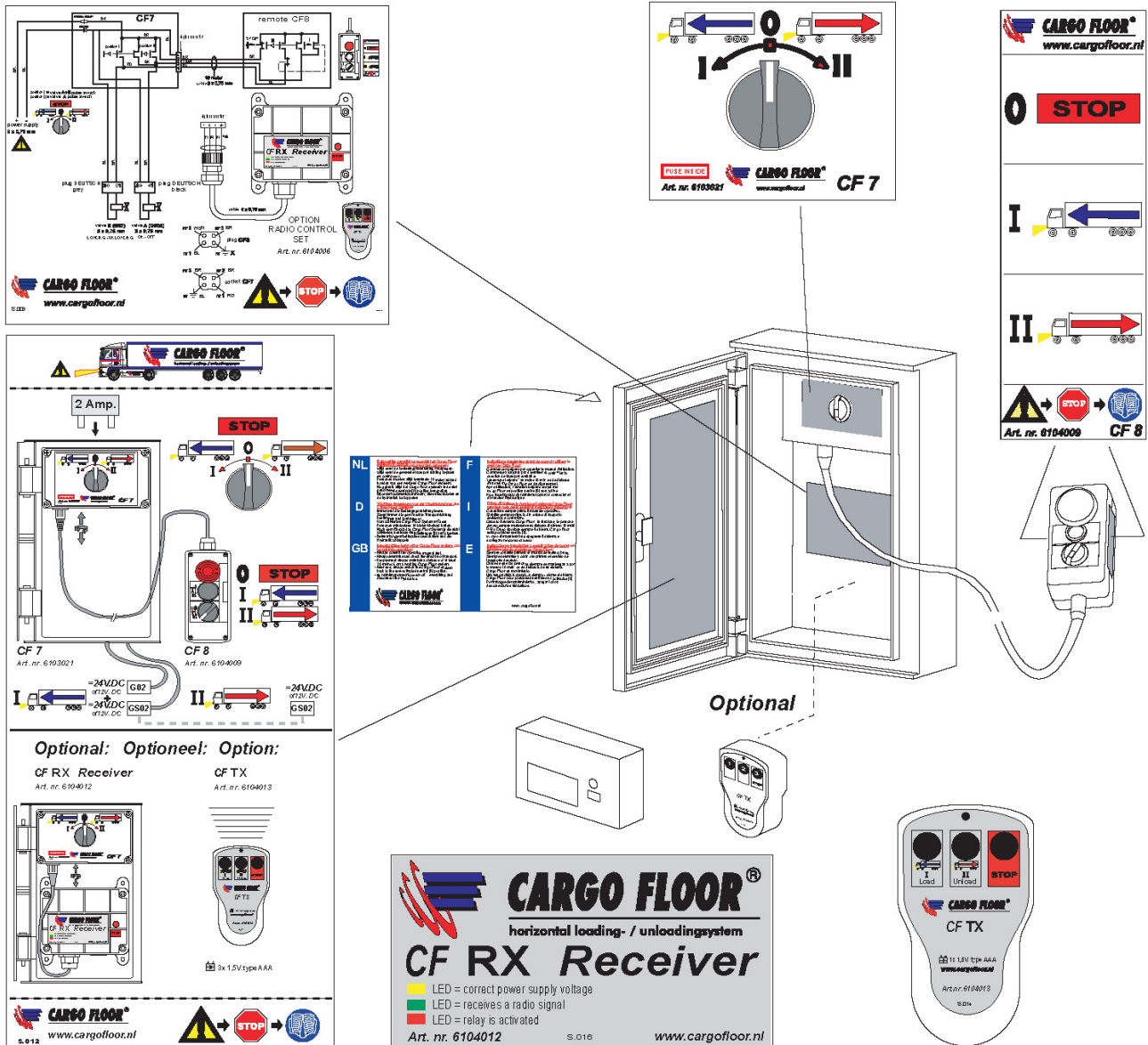

## FUNCTION OF “E”-CONTROL SWITCHES

### CF 7 SWITCH (EMERGENCY CONTROL)

The CF 7 switch is the permanent switch which is mounted on the frame/vehicle and has 3 switch positions with the following functions:

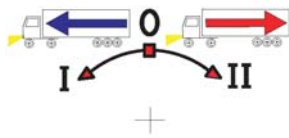

Pos I = loading

is activated when you turn the rotary switch to the left.

Pos 0 = stop

the rotary switch automatically returns to this position when the switch is released.

Pos II = unloading

is activated when you turn the rotary switch to the right.



In the interest of safety this switch is fitted with an automatic spring-back for positions I and II, so that it always returns to the central “0” position. This is necessary to prevent conflict situations arising when using the CF 8 remote control.

Mounted below the CF 7 switch, is a connector to which the CF 8 switch or the RX RECEIVER can be connected without the need for any adjustments.

Normally, the CF 7 switch should only be used if the CF 8 switch is defective.

If, after the initial assembly, the switch doesn't work it's probable that the connections for the + (brown) and the - (blue) have been swapped around. The supply cable contains a blocking diode which prevents the + and - from being connected in reverse.

A 2 Amp fuse has been mounted in the CF 7 switch. Never mount a fuse over 3A, this can cause damage to the electrical installation

### CF 8 SWITCH (MAIN CONTROL)

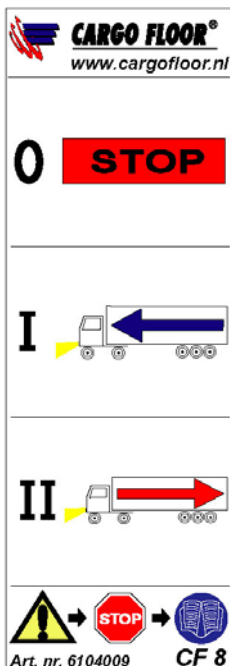

The remote control CF 8, which is supplied standard with 10 m. of cable, is used for the day-to-day control of the system.

The CF8 switch is fitted with the following control buttons:

**Red button:** the stop button. Press the button to stop the unit, and turn it to release the button;

**Middle (push) button.** Pushing this button starts the system loading (pos. I). When this button is released the system stops. The user must keep this button pushed in during loading, for safety purpose;

**Lowest (rotary) switch.** This is a rotary switch with two positions. Activating this switch starts the system unloading (pos. II). When this switch is deactivated the system stops.

Before a new function can be switched on the previous function must be cancelled.

The CF 8 switch has a plug connector, which can be inserted into the connector of the CF 7 switch and screwed tight.

To disconnect this, the duct must be unscrewed, after which the plug can be pulled out. Normally, this plug should always be connected to the connector.

## OPTIONAL

A radio controlled remote control is available as an option.

This incorporates:



**CF RX Receiver** which has a plug connector which can be inserted into the connector of the CF 7 switch and screwed tight. To disconnect this the duct must be unscrewed, after which the plug can be pulled out. Normally, this plug should always be connected to the connector.

## Red stop button

On the receiver RX a red stop button is mounted, by pushing this button you can stop the system in case of emergency. By pushing it again the system will be activated again. Do take care, with reference to the accessibility, that when using a remote control, the door of the switching box CF7 is opened so the red stop button can be operated.

**CF TX Remote Control**, this has 3 buttons, which work as follows:



**Button one (loading).** By pushing this button the system will load, by releasing it the system will stop (or you push to stop the big stop button).

**Button two (unloading).** By pushing this button the system will unload, by pushing it again the system will stop (or you push to stop the big stop button).

**Button three.** With this button you stop the system.

The switching positions I-0-II (applicable to all switches) energize the following solenoids (provided that they have been connected correctly):

- **Position II (unloading):** only the solenoid of valve A (GS02) is energized. A voltage of 24 VDC (12 VDC) is supplied to the solenoid
- **Position I (loading):** the solenoids of valve A (GS02) and valve B (G02) are energized. A voltage of 24 VDC (12 VDC) is supplied to both solenoids
- **Position 0:** stop, the solenoids are not energized

## IMPORTANT

Before starting to load or unload you must check the following:

- there must be no people in the vicinity of the system;
- there must not be anything to obstruct the transport of the product (are the doors open?);
- bear in mind which action you want the system to carry out-Loading or Unloading? Immediately check, and continue to check, whether the system is transporting the product in the correct direction. Pay special attention when loading to ensure that the product is not pressed up against the bulkhead.
- Turn on the pump;
- Turn on the light and check that there is a supply of power.
- Keep your distance from the vehicle and operate it by means of the remote control CF 8 or the CF RX.

In the event of malfunctions in the electrical system, the standard manual operation mode can be used to activate the On/Off functions. See page 20. **When using this manual control you must always ensure that it is switched back to the original NON-ACTIVATED condition after use.**

### ELECTRICAL CIRCUIT DIAGRAM "E"-CONTROL

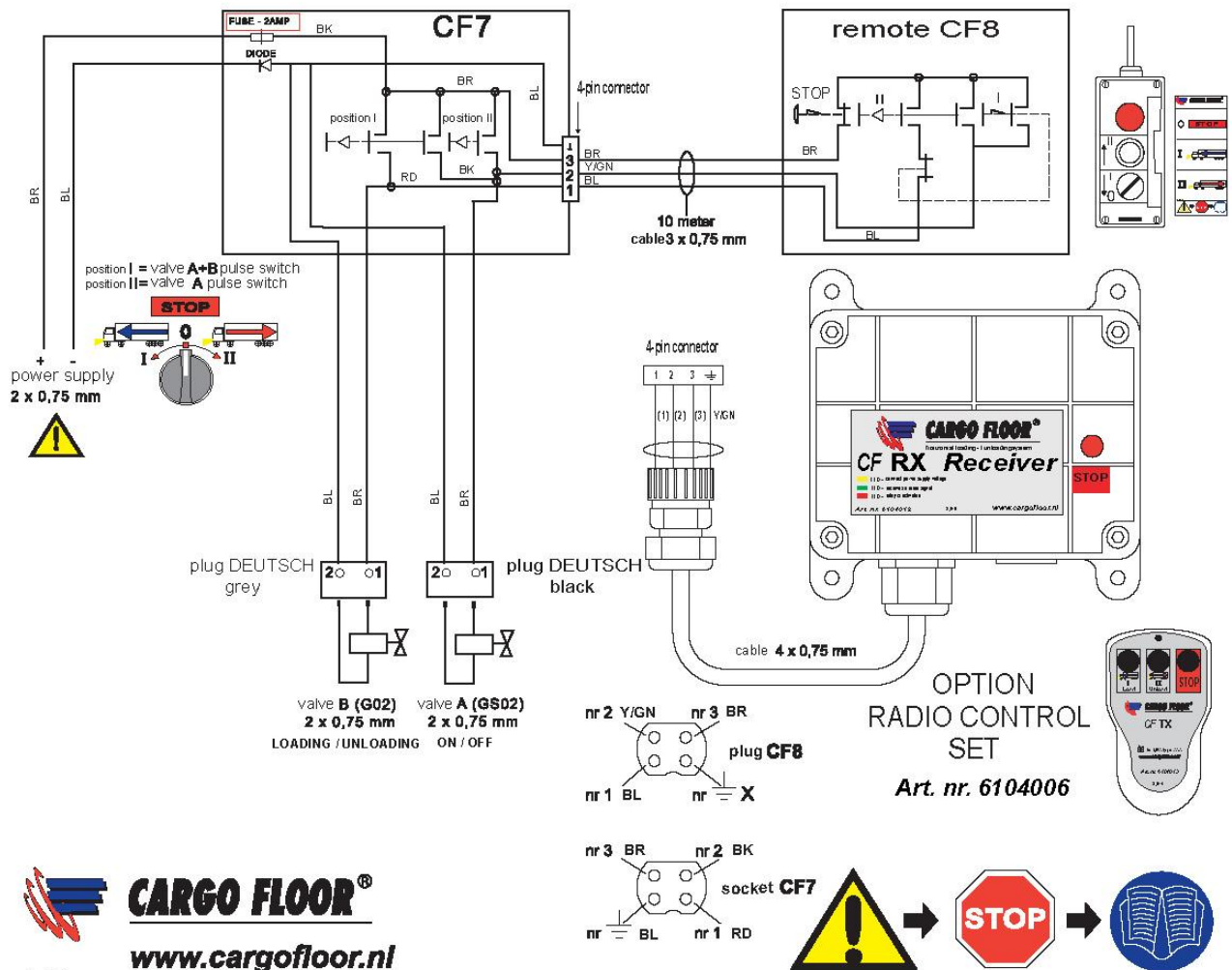

### CONTROL VALVE "E"-CONTROL

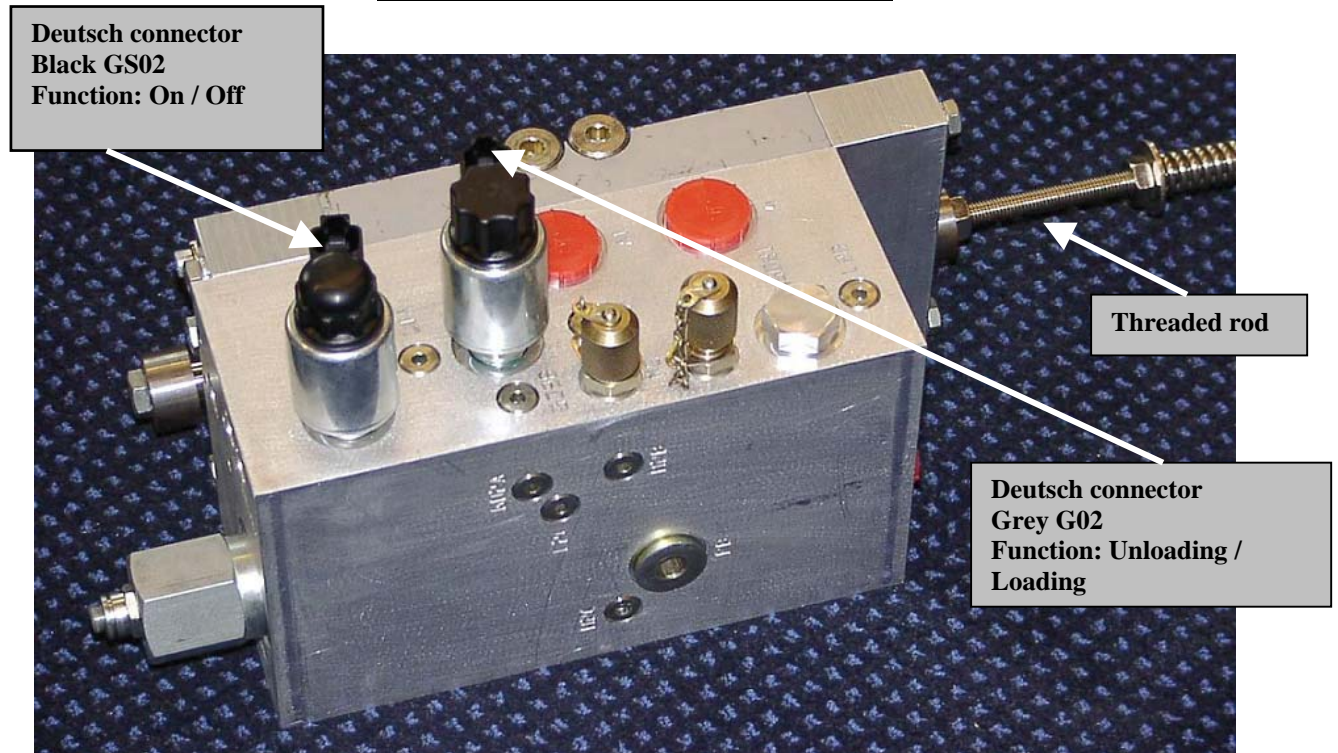



**HYDRAULIC CIRCUIT DIAGRAM “E”-CONTROL**

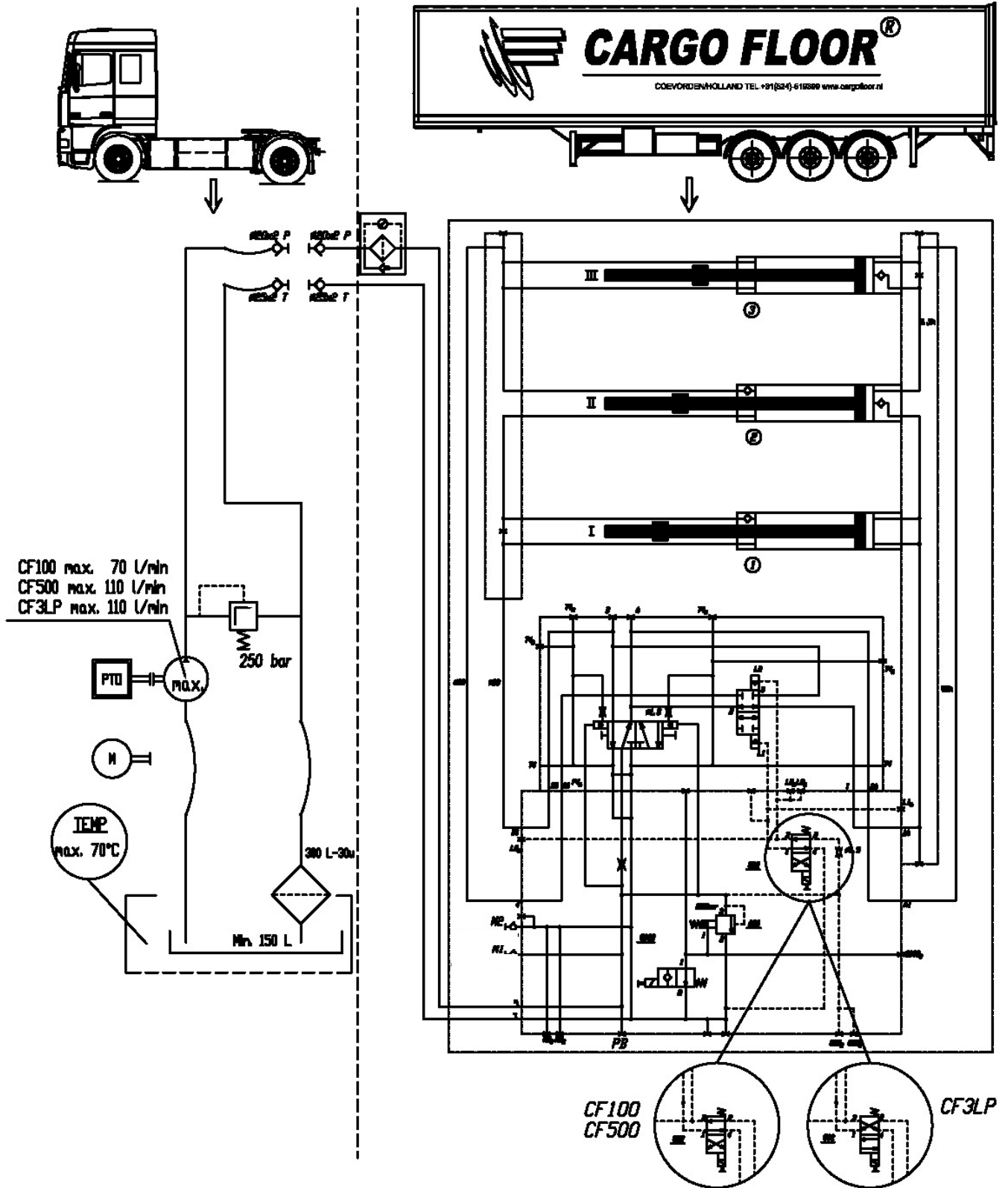

## STICKERS "B"-CONTROL

These stickers, which are delivered with the Cargo Floor systems, should be applied to the vehicle, in the neighbourhood of the described operation.

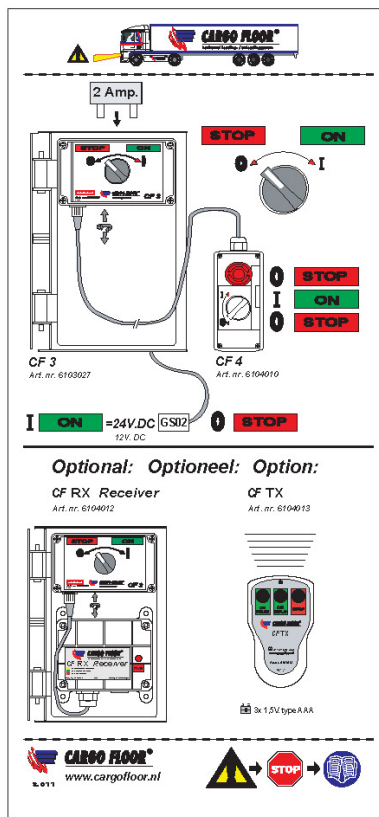
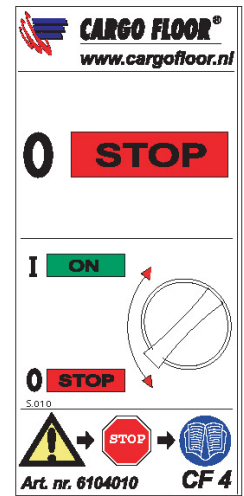
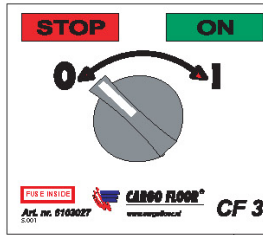
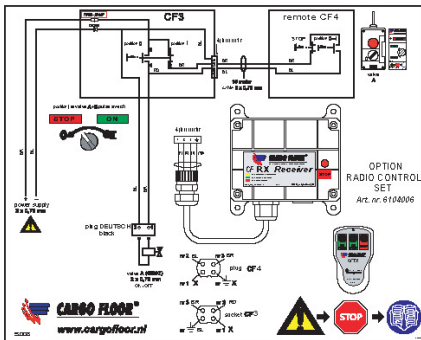

NL: Het gebruik van de Cargo Floor®...  
D: Das System ist für den Einsatz...  
GB: This system is designed for use...

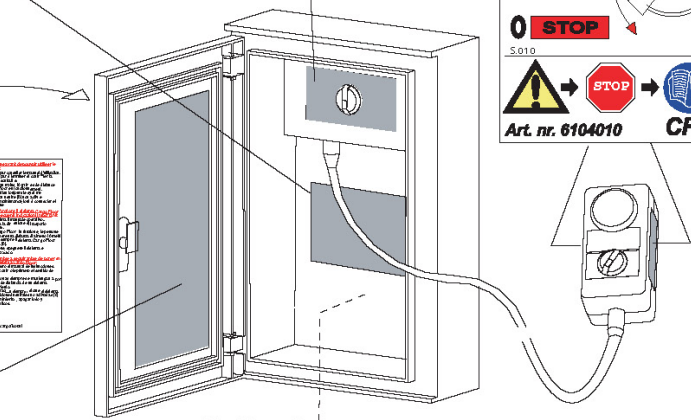

Optional

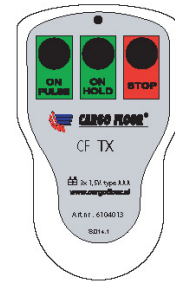

Operating handle, Loading / Unloading

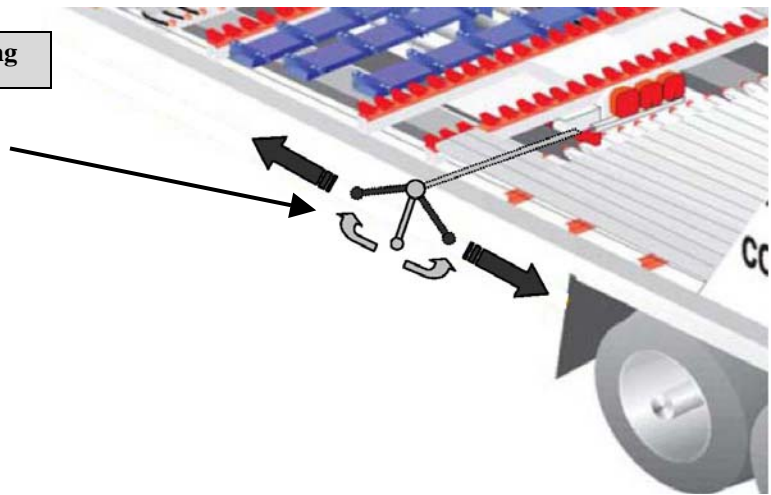

## FUNCTION OF “B”-CONTROL SWITCHES

### CF 3 SWITCH (EMERGENCY CONTROL)

The CF 3 switch is the permanent switch which is mounted on the frame/vehicle and has 2 switch positions with the following functions:

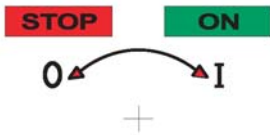

Pos 0 = stop. The rotary switch automatically returns to this position when the switch is released.

Pos II = on. Is activated when you turn the rotary switch to the right.



CF 3

In the interest of safety this switch is fitted with an automatic spring-back for position I, so that it always returns to “0” position. This is necessary to prevent conflict situations arising when using the CF 4 remote control.

Mounted below the CF 3 switch, is a connector to which the CF 4 switch or the RX RECEIVER can be connected without the need for any adjustments.

Normally, the CF 3 switch should only be used if the CF 4 switch is defective.

If, after the initial assembly, the switch doesn't work it's probable that the connections for the + (brown) and the - (blue) have been swapped around. The supply cable contains a blocking diode which prevents the + and - from being connected in reverse.

A 2 Amp fuse has been mounted in the CF 3 switch. Never mount a fuse over 3A, this can cause damage to the electrical installation

### CF 4 SWITCH (MAIN CONTROL)



The remote control CF 4, which is supplied standard with 10 m. of cable, is used for the day-to-day control of the system.

The CF 4 switch has the following buttons:



**Red button:** the stop button. This is activated by pushing it in and deactivated by turning it;



**Lowest (rotary) switch.** This is a rotary switch with two positions. Activating this switch starts the system unloading (pos. I). When this switch is deactivated the system stops.

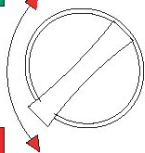

Before a new function can be switched on the previous function must be cancelled.



Art. nr. 6104010

CF 4

The CF 4 switch has a plug connector, which can be inserted into the connector of the CF 3 switch and screwed tight.

To disconnect this, the duct must be unscrewed, after which the plug can be pulled out. Normally, this plug should always be connected to the connector.

## OPTIONAL

A radio controlled remote control is available as an option.



This incorporates:

**CF RX Receiver** which has a plug connector which can be inserted into the connector of the CF 3 switch and screwed tight.

To disconnect this the duct must be unscrewed, after which the plug can be pulled out. Normally, this plug should always be connected to the connector.

## CF TX Remote Control



Fitted with three control buttons with the following functions:

**Button one (on ON PULSE as pulse contact).** By pushing this button the system will be activated, by releasing it the system will deactivate (or you push to stop the stop button).

**Button two (aan/ON HOLD as hold contact).** By pushing this button the system will be activated, by pushing it again the system will deactivate (or you push to stop the stop button).

**Button three.** With this button you stop the system.

The switching positions 0-II (applicable to all switches) energize the following solenoid (provided that they have been connected correctly):

- **Position I (On):** only the solenoid of valve A (GS02) is energized.
- **Position 0 (Stop):** no solenoids may be energized.

## LOADING – UNLOADING FUNCTION

The loading or unloading modes can be selected using the handle located under the trailer, see the illustration.

The position of the handle also indicates the direction in which the load will be transported:

**0** handle in the middle position, floor is stationary

**I** handle pointing towards the back doors; floor will move in the unloading direction

**II** handle pointing towards the tractor unit; floor will move in the loading direction

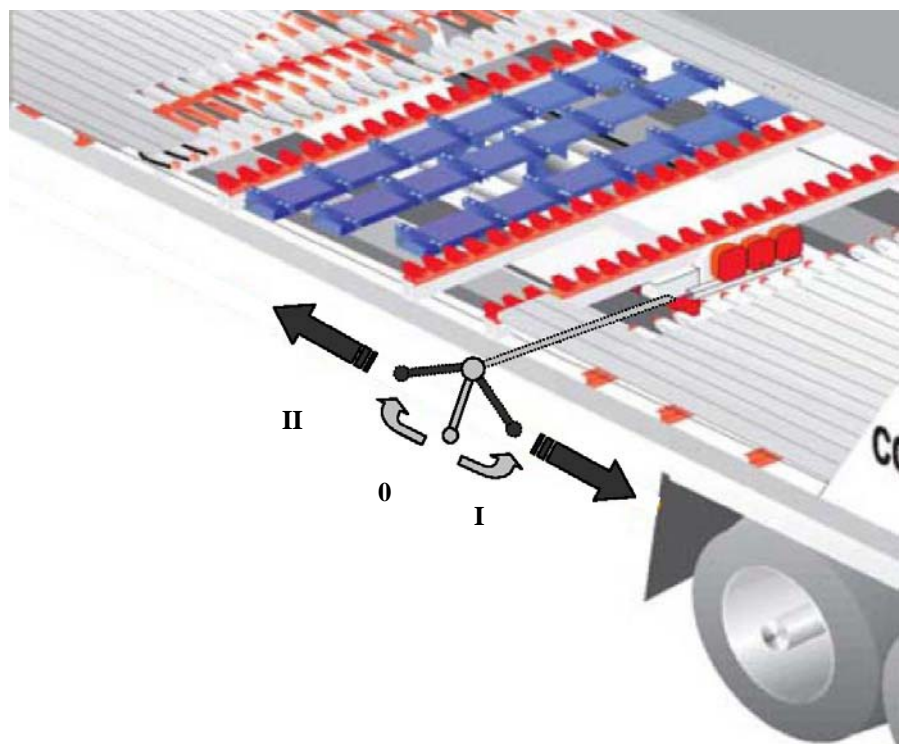

### ELECTRICAL CIRCUIT DIAGRAM "B"-CONTROL

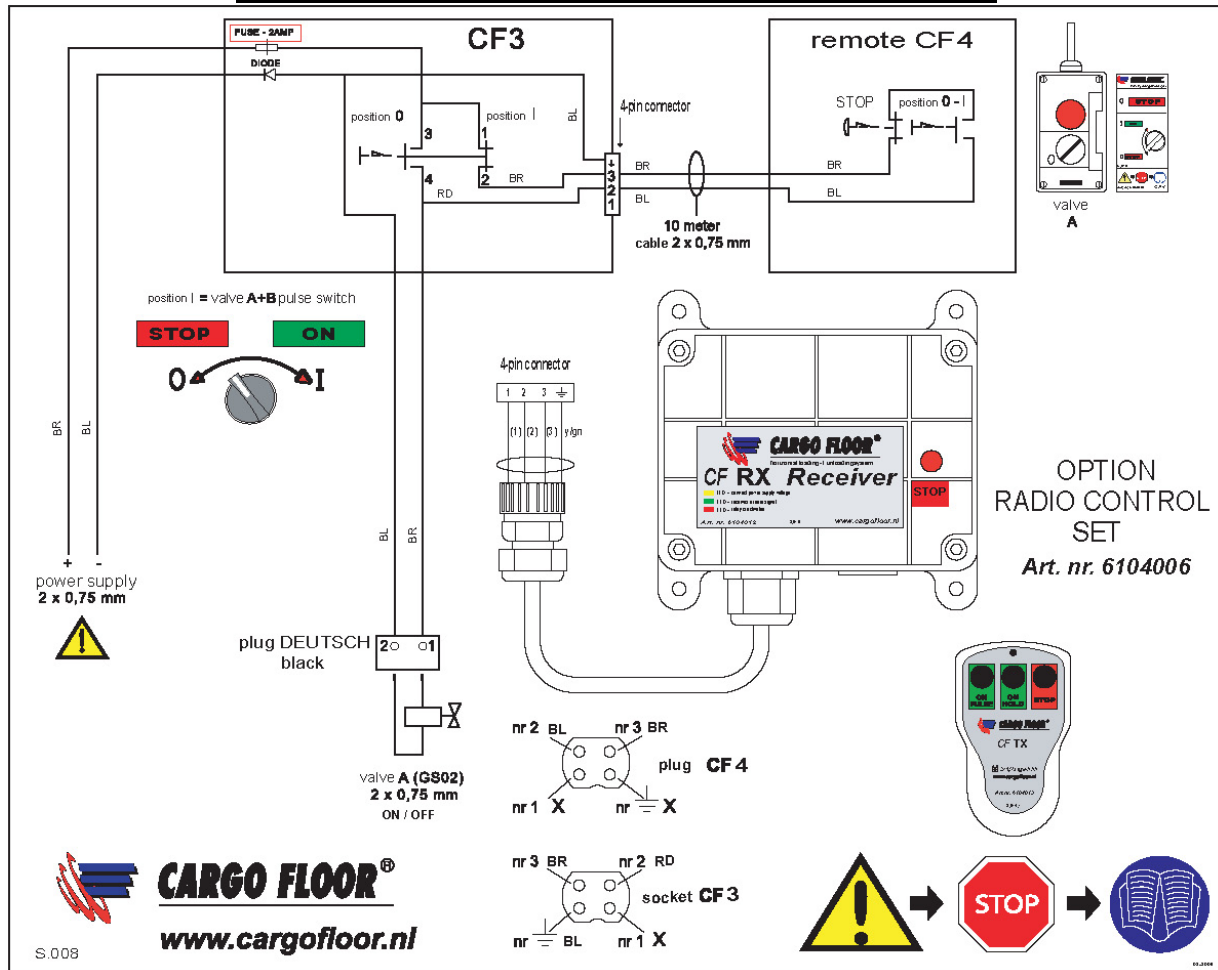

### CONTROLE VALVE "B"-OPERATION

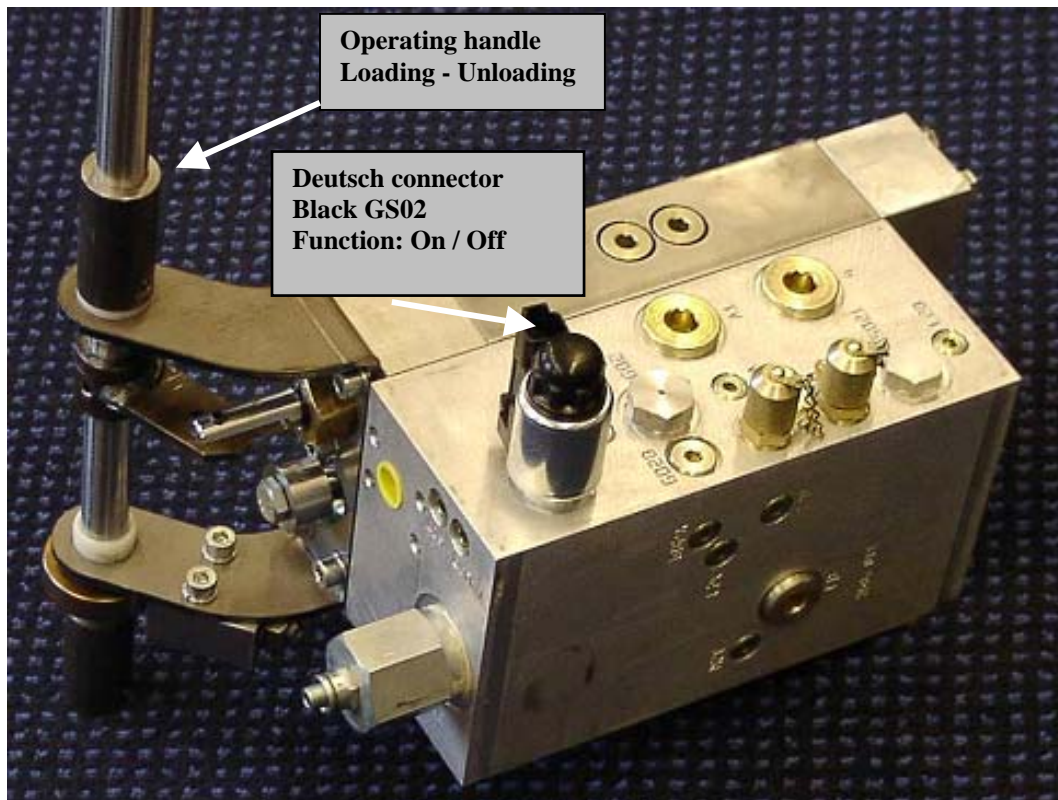

**HYDRAULIC CIRCUIT DIAGRAM “B”-CONTROL**

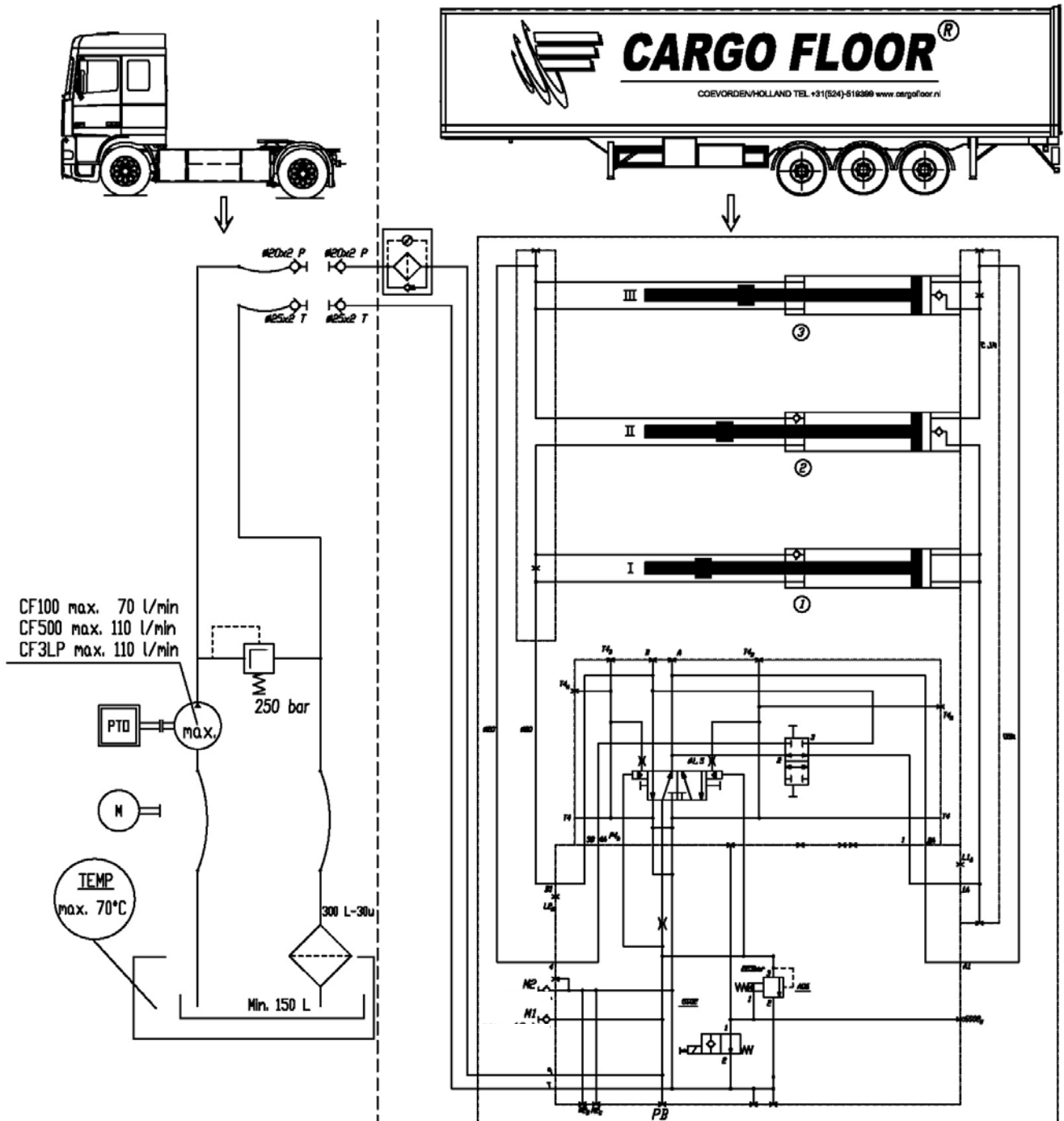

## CONTROL OPTIONS “A”-CONTROL

Units fitted with A-controls do not include a separate on/off switch for the Cargo Floor system; the floor will begin to move once the Pump/PTO is switched on. The direction in which the floor moves will depend on the position of the operating handle mounted under the trailer.

### LOADING – UNLOADING FUNCTION

The loading or unloading modes can be selected using the handle located under the trailer, see the illustration.

The position of the handle also indicates the direction in which the load will be transported:

**0** handle in the middle position, floor is stationary

**I** handle pointing towards the back doors; floor will move in the unloading direction

**II** handle pointing towards the tractor unit; floor will move in the loading direction

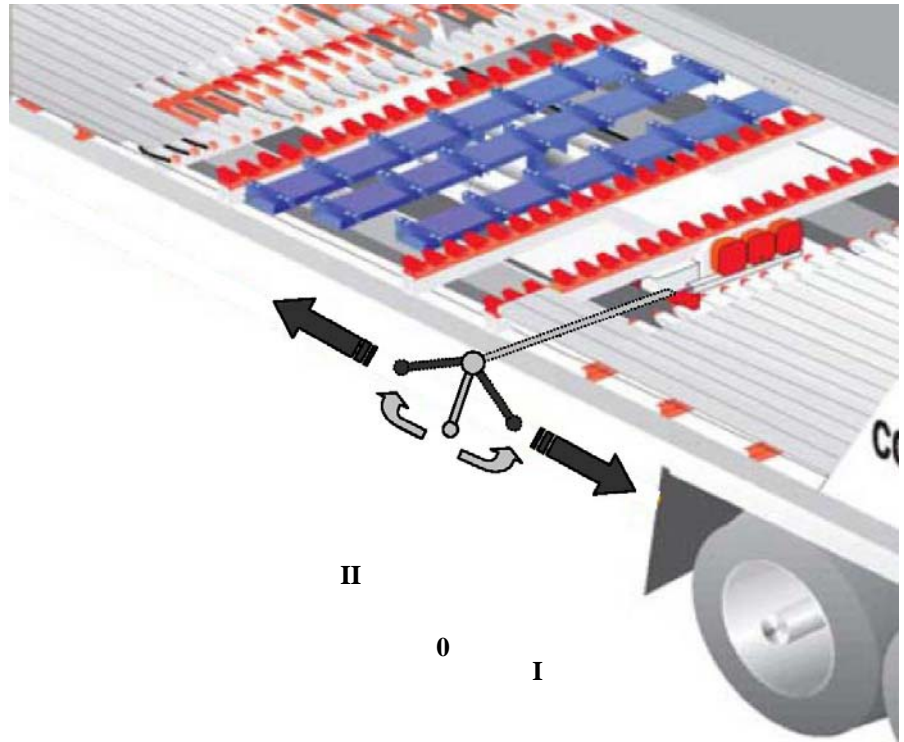

**WARNING ! SWITCHING ON THE PUMP/PTO WILL START THE FLOOR MOVING!**

## CONTROL VALVE “A”-CONTROL

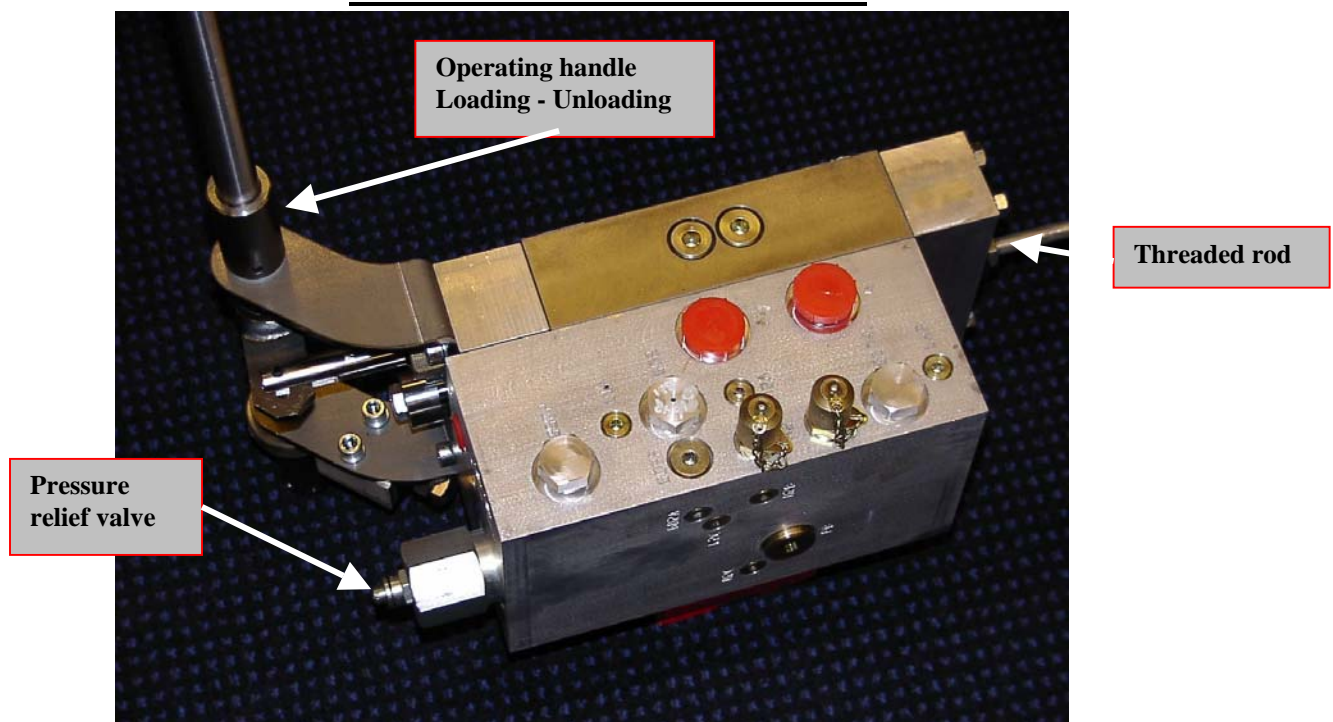

**HYDRAULIC CIRCUIT DIAGRAM "A"-CONTROL**

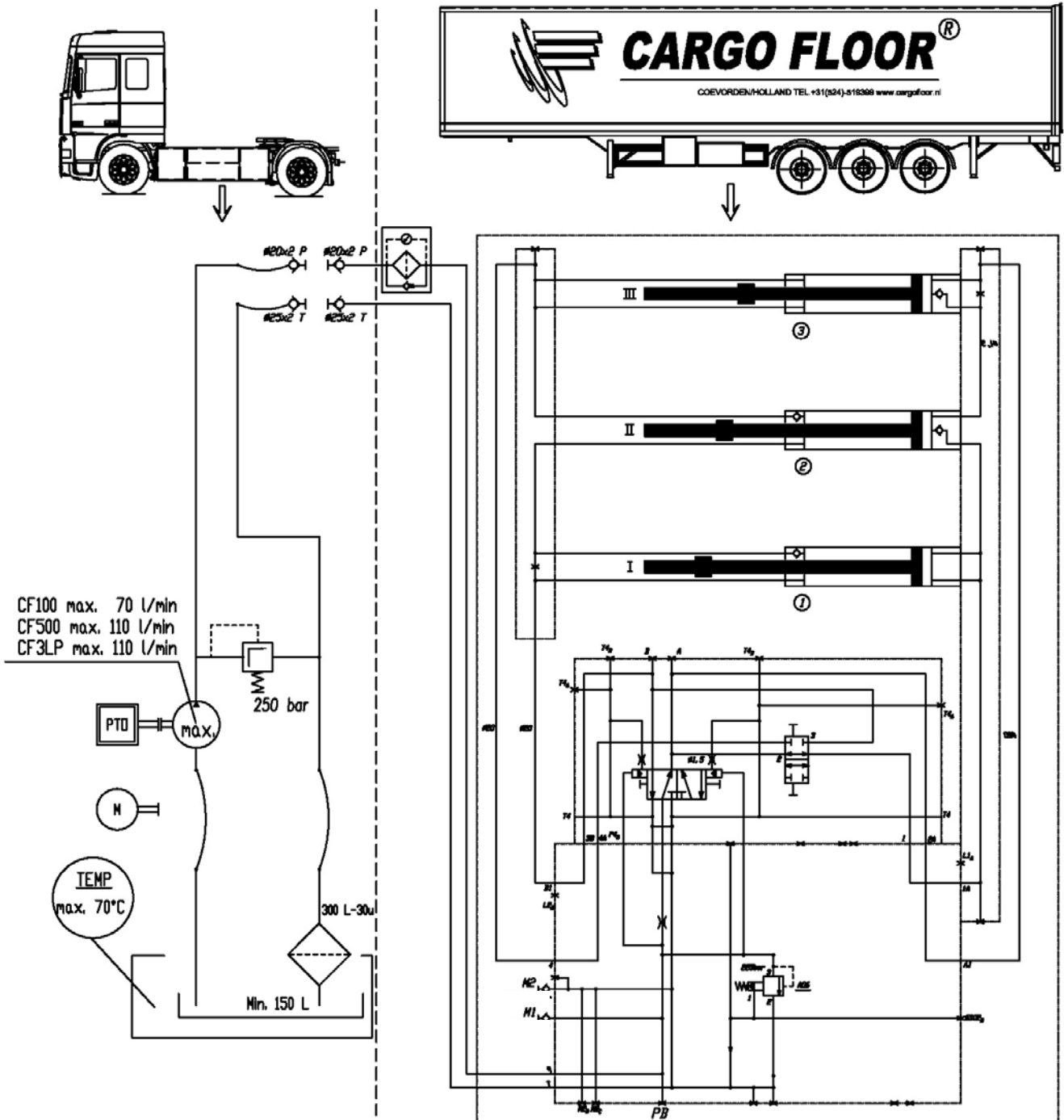



## CARGO FLOOR TECHNICAL SPECIFICATIONS

- System Operation** : completely hydraulic, with three double-action cylinders.  
**System Control** : completely hydraulic mechanical.  
**Operation Control** : fully automatic loading – stop – unloading

	<b>CF500 SL(i)</b>	<b>CF500 SL Power Speed</b>	<b>CF100 SLL(i)</b>	<b>CF 3 LP (leak proof)</b>
Stroke (mm)	200	200	150	150
Bore (mm)	100/45	100/45	80/35	125/60
Cylinder volume (ltr.)	2.82	2.82	1.36	3.26
Oil volume per cycle (ltr.)	8.46	8.46	4.09	9.77
Max. operational pressure (bar)	225	225	175	150
Over pressure valve threshold (bar)	225	225	175	150
Strokes per minute	13	21	17	11
Speed, in meters per minute (mtr. / min with advised pump capacity)	2.6	4,2	2.6	1.7
Advised pump capacity:				
Flow (ltr./min)	110	180	70	110
Pressure (bar)	250	250	200	175
Max. pump capacity:				
Flow (ltr./min)	130	200	80	170
Pressure (bar)	250	250	200	175
Speed	3,1	4,7	2,9	2,6

- Control valves** : 24VDC; (12VDC, as an option)  
**Throughput variation** : Completely variable speed by use of oil flow determined by the revs of the motor or by various pumps.
- Drive** : use of the PTO on the truck; an electro-hydraulic aggregate or an aggregate with an external combustion engine.
- Filter** : pressure filter type: high-pressure 20 micron.  
(Artikelnummer 7072004)
- Pressure piping** : Ø 20 x 2 feed through 16 mm  
**Return piping** : Ø 25 x 2,5 feed through 20 mm  
**Oil ISO VG 32 b.v.** : Shell Tellus T32 or BP HL2-32 or ESSO Unavis 32 (or equivalent).  
Only use biological oil after agreement by Cargo Floor
- Biological oil** : Synthetic-ester (HEES) oil is suitable for all units. **We advise you not to make use of other types of biological oil.**
- Oil temperature** : max. 70 ° C

## **Floor**

- Aluminium floor profiles** : - plank length negotiable  
- floor thickness 3, 6, 8, 10, HDI 8/18 mm. HD 8/20 mm; Semi Leak Proof  
- plank width 111.5 mm  
- moving floor width standard 2355 mm for an inner width of 2500 mm
- Extrusion alloy** : high quality Aluminium-alloy, weldable, very wear-proof and tensile
- Composite floor profiles** : these floor variants are only available in consultation with Cargo Floor B.V. due to the specific nature of this type of application
- Material** : high quality fibre reinforced plastic
- Guiding** : The aluminium floor profiles are borne by wear-free plastic guides (TWISTER) or by plastic guide cams.
- Guide bearing surface** : the total bearing surface of each guide (TWISTER) is 87 cm<sup>2</sup>  
Total bearing surface of each guiding block of the plastic cam guide is 60 cm<sup>2</sup>  
Total guide surface area is determined by the total number of guides, which can be varied as required.
- Under floor** : Steel, aluminium and composite. The plastic guiding can be provided with square tubes 25x25x2 or the plastic cam guides can be mounted directly on the under floor.

## **OPTIONS:**

- (i) module for connecting to Blackbox
- Variable stroke from 10 mm to 200 mm
- Can be connected to PLC
- Control valves 12 V or 220 V (24 V=standard).
- Steel floor parts, Steel clad floor parts.
- Floor width and length in consultation, can be any width required.
- Aluminium end caps for floor profiles
- Completely flat profiles are available for special products, floor thickness 6, 8 and 10 mm
- Protective roll-up cover;
- Wireless remote control with load and unload functions (art. no.6104006);
- Cargo Floor in combination with other loading/unloading systems (for example Joloda, Rolamat, Transpotec, etc.)
- Stationary applications in all versions
- Extra plastic guides.
- Electro- / hydraulic aggregates
- Diesel hydraulic aggregates
- Multiple bulkhead for partial loads

### PUMP SPECIFICATIONS

The pump unit used to power the Cargo Floor system must comply with the following specifications:

**NOTE! Verify which unit is fitted!**

	CF 500 SL(i)	Power Speed	CF 100 SLL (i)	CF 3 LP
Pump capacity (in ltr./min)	<b>110</b>	<b>180</b>	<b>70</b>	<b>110</b>
Max. pressure (bar)	<b>250</b>	<b>250</b>	<b>200</b>	<b>175</b>

Oil tank, contents of min. 150 ltr., see page 22, provided with:

- return filter (30 micron) 300 ltr.
- tank cover
- oil level glass
- draining tap
- filling cap

Pipes complying with the following requirements:

- pressure line min. 20 x 2 mm
- return line min. 25 x 2,5 mm
- quick-detachable couplings (suitable for 110 l/min.).

The pump volume determines the transport speed;  
The pressure determines the force applied to the system and the load that can be moved.

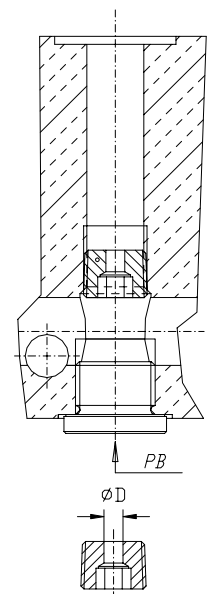
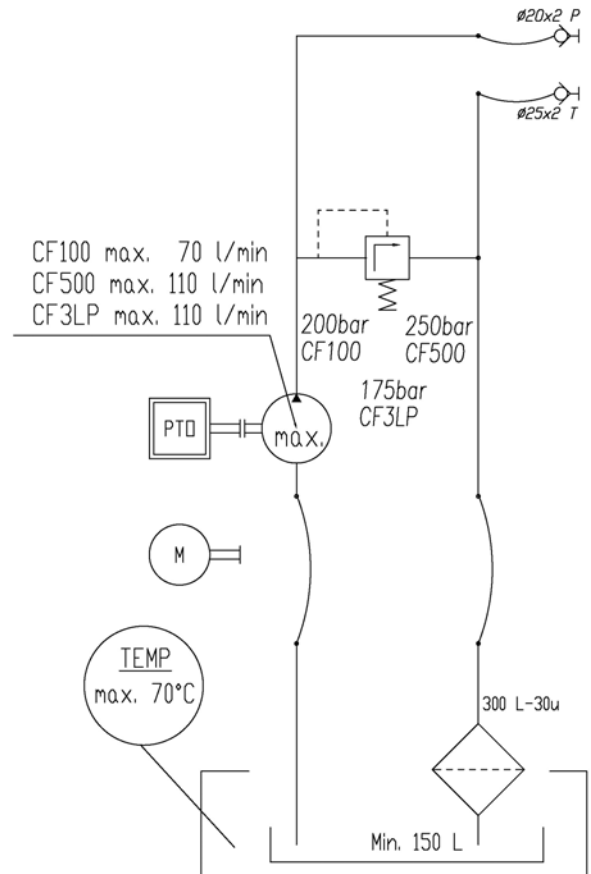
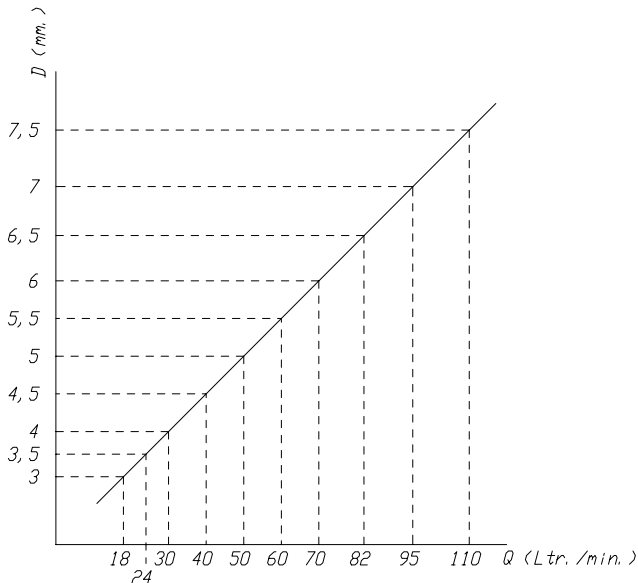

DIN 906-5. 8-3/8"  
Standard Ø6,5 mm

### Choke:

There is a choke mounted as standard in the PB channel of the control valve. This allows the control valve to function correctly. This choke is suitable for an oil flow level of 80 to 110 litres per minute. The function of the control block can be affected by a deviation from this oil flow level. The oil flow diagram shows which level of oil flow is required by which opening. Adjustment of this is possible by simply changing the diameter of the choke.

Known consequences of a wrong choke diameter are:

- Oil flow too low: load/unload valve not switching, floor does not get into loading state, or will not leave loading state;
- Oil flow too high: noise in system and high heat dissipation.

### EMERGENCY CONTROL

In the event of a malfunction in the electrical system the electric valve can still be operated by pressing the cartridge fitted for that purpose (manual control, see photo).

**MAKE SURE THAT THE DOORS ARE OPEN!**

**When using this manual control you must always ensure that it switched back to the original, NON-ACTIVATED condition after use.**

#### **Activation of the emergency control on:**

Press the button on top of solenoid GS02, until it reaches the stop and keep it pressed in.

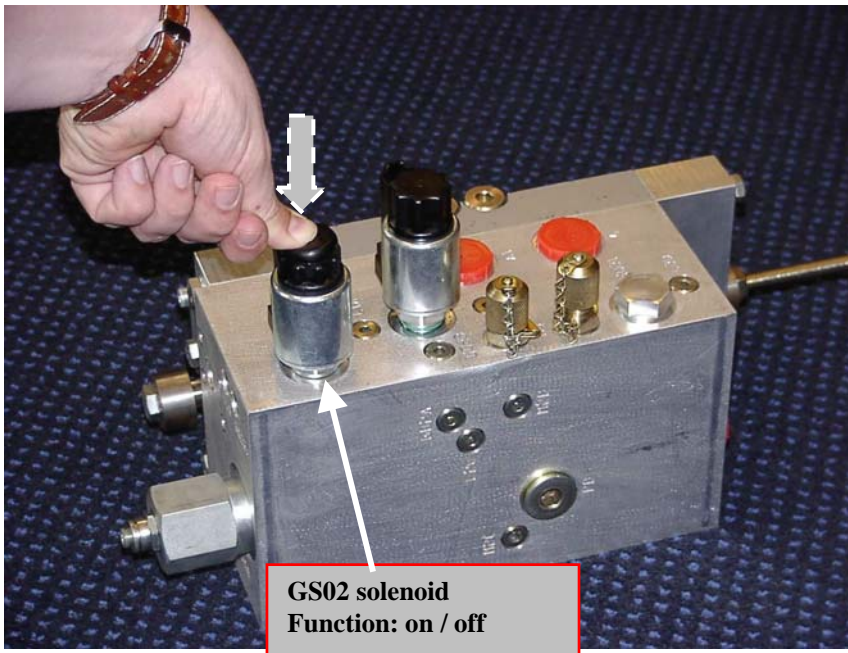

#### **Activation of the emergency control loading:**

Turn the screw beneath the cap of the G02 out until the stop.

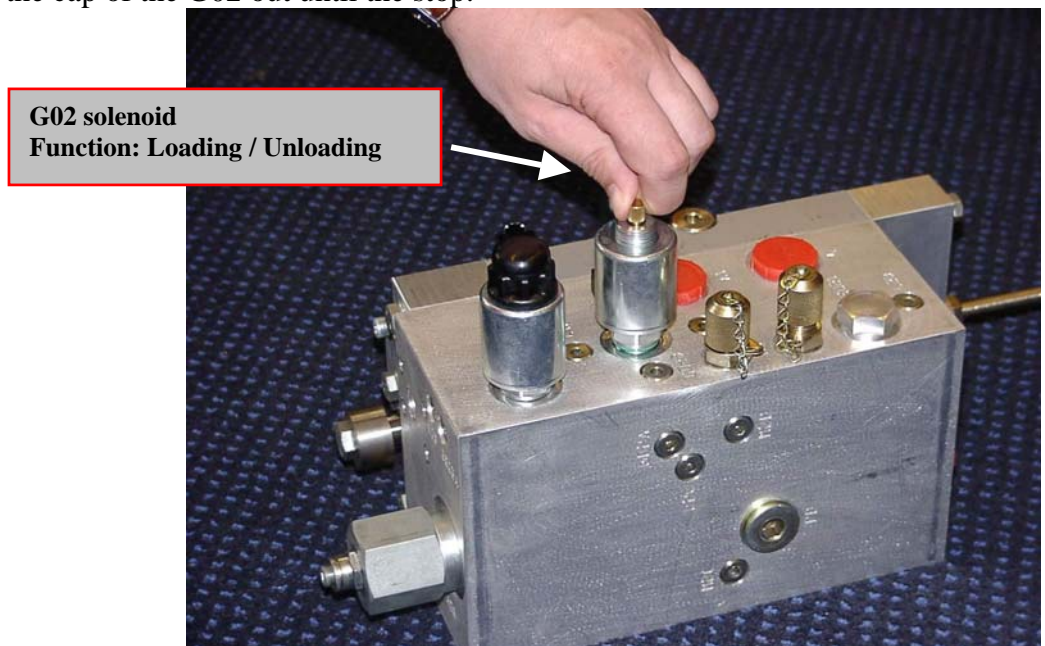

#### **Deactivation of the emergency controls:**

Release the button on top of the GS02 solenoid.

Turn **in** the screw of the G02 solenoid until the stop.

## ADJUSTING THE CONTROL VALVE

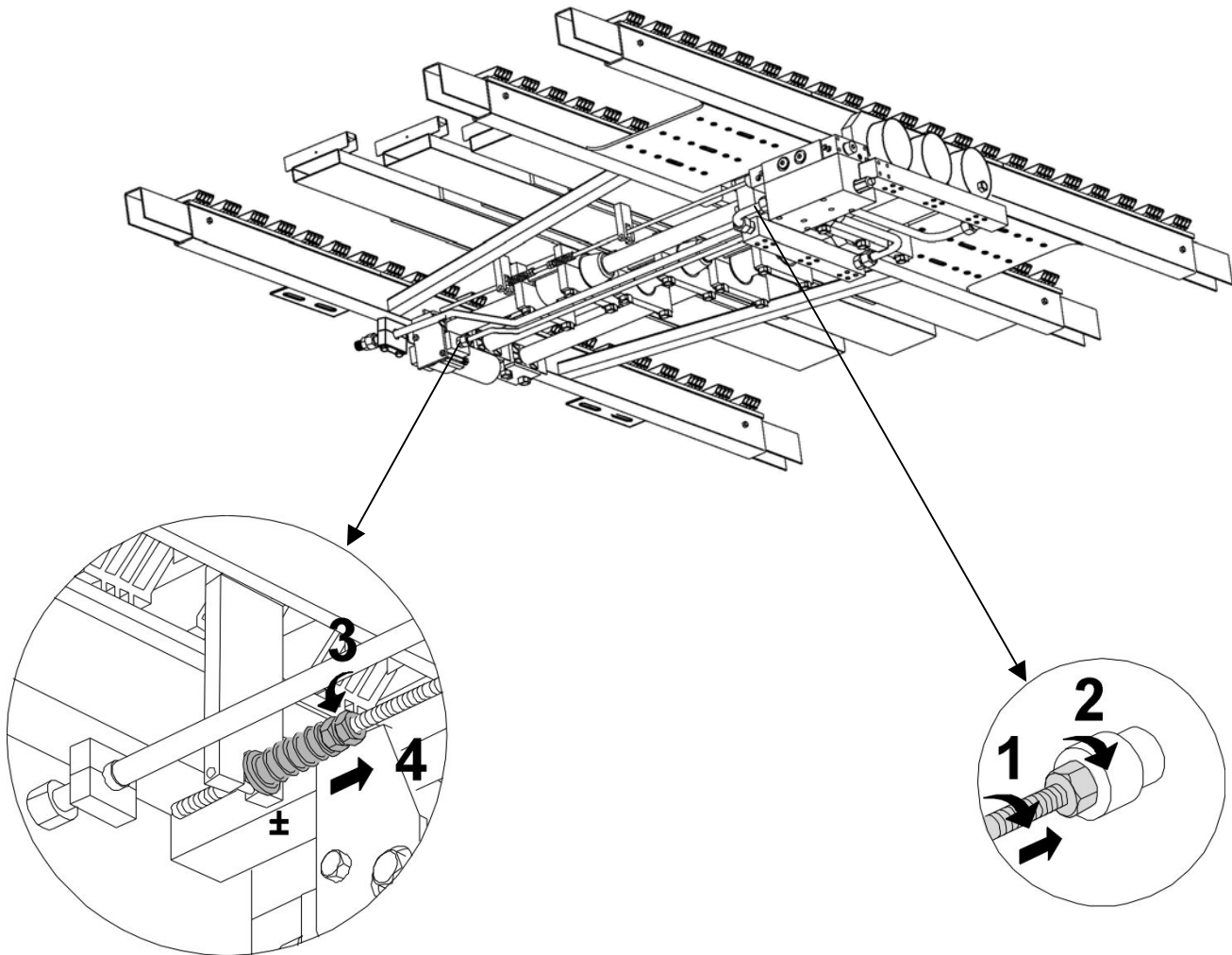

The Cargo Floor systems are already adjusted and tested when you take them over. In certain circumstances (moved combination valve) it may be necessary to check the adjustment. You can do this as follows:

### Necessary tools:

- 2x spanner 17;
- High viscosity oil;
- Copper grease;
- Steel brush.

Check that the wire rod is fastened securely to the control valve plunger, stroke exactly 12 mm (see figure 33). If not, then screw the wire rod (1) as far as possible into the plunger and secure this with the contra nut (2) (spanner size 17).

Loosen nuts 3 and 4 (spanner size 17) and move these about 3 cm in the direction of the control valve. Now switch the pump on. The system will stop now at the point where the command lip no longer operates the control valve. Switch off the pump.

Now push the wire rod 1 in until the spacer ring 2 touches the control valve.

Tighten nuts 3 and 4 so that the spring is fully tensioned, and secure them by tightening them against one another. Repeat this procedure for the other side.

**N.B. It is worthwhile spreading some copper grease on the threaded rod 1.**

## MAINTENANCE INSTRUCTIONS

### Check after receipt of the new trailer:

Check the join between the aluminium floor profiles and the Cargo Floor-system. If there is play then either tighten the bolts or replace them. Check this a couple of days after receipt of the trailer, after 10 loads / unloads and after one month.

Specifications of the screws:

M12 x 25 countersunk screws with hexagon socket, class 10.9, galvanized. DIN 7991

Loctite must be applied to the threaded surfaces of the bolts (Loctite® 243 cat. o. 23286 thread locking).

A torque of 100 – 140 Nm should be used to tighten the bolts.

### Regular checks:

To ensure that your Cargo Floor system operates reliably and has a long life, it is important that you regularly perform careful checks on the following aspects:

- The quality of the oil; this must be cleaned regularly (check every ½ year)
- Replace the filter element every year;
- Change the oil every 2 years, or more frequently if required;
- The level of oil in the tank. The oil should be kept at a level of at least 150 litres to prevent overheating. Use a good quality, hydraulic oil in accordance with the ISO VG 32 norm.

### Check and, if necessary clean the following components:

- Screws/bolts: are they still tight, tighten or replace if necessary!
- Check the ducts and joints of all hydraulic components, and adjust if necessary!
- Oil tank;  
By taking the lid off the tank, you can remove any remains (condensation, dirt etc.) from the bottom.
- Return-/pressure filter  
You can check the filter elements or replace. You gain access by removing the filter lid/ chamber.

This is all necessary to avoid internal wear (of the pump/cylinders etc., for example).

New filter parts are available at your system builder. For the right type we refer you to our “exploded views” which you can find on our website: [www.cargofloor.nl/download](http://www.cargofloor.nl/download).

We want to emphasize that the minimal costs of replacing dirty parts or oil do not match the costs and discomfort that can proceed out of this.

- Control valve;  
Adjustment of the control valve. It is important that the control valve is correctly adjusted and that the switchover moment occurs according to the procedures. See page 21.

Cleaning the floor parts with a steam cleaner is also part of the regular preventative maintenance.

## TROUBLESHOOTING

In the event of the failure of the Cargo Floor system to operate (in the correct manner) when used in accordance with the operating instructions carry out the following checks:

<b>malfunction</b>	<b>cause</b>	<b>remedy</b>
<b>1. floor does not move in either the loading or unloading direction</b>	No hydraulic pressure	<ol style="list-style-type: none"> <li>1. Switch on PTO / pump</li> <li>2. Check quick-detachable couplings between tractor unit and trailer; where relevant, lock in position</li> </ol>
<b>2. floor does not move in either the loading or unloading direction; the hydraulic system is at working pressure</b>	No power supply	<ol style="list-style-type: none"> <li>1. Switch on lights</li> <li>2. Switch on control cabinet</li> <li>3. Measure power supply to control cabinet</li> </ol>
<b>3. no power supply to the control cabinet; the lighting is switched on</b>	Break in cable, incorrect connections	<ol style="list-style-type: none"> <li>1. Trace the cause of the electrical malfunction in the circuit between the control cabinet and the trailer lighting</li> </ol>
<b>4. floor does not move in either the loading or unloading direction; the hydraulic system is at working pressure, and power is supplied to the control cabinet</b>	Blocked quick-detachable coupling – note, also the return line!	<ol style="list-style-type: none"> <li>1. Check the quick-detachable couplings, and unblock if necessary</li> </ol>
<b>4a. floor does not move in either the loading or unloading direction; the hydraulic system is at working pressure, and power is supplied to the control cabinet</b>	Hydraulic oil released via the pressure relief valve fitted to either the tractor unit or the system	Check whether oil is released via the pressure relief valve fitted to either the tractor unit or the trailer. This can be determined from the hissing sound made by the valve.
<b>4b. pressure relief valve on the tractor unit is activated</b>	System does not achieve working pressure	<ol style="list-style-type: none"> <li>1. If a tipping valve is fitted, is it in the correct position?</li> <li>2. Measure the pressure at the pump, have the pressure adjusted if necessary.</li> </ol>
<b>4c. pressure relief valve on the semi-trailer is activated</b>	Measure the pressure at measurement point M1, pressure above 225 bar	<ol style="list-style-type: none"> <li>1. Check the setting of the threaded rod</li> <li>2. Capacity of the system is insufficient to move the load.</li> </ol>
<b>4d. capacity of the system is insufficient to move the load</b>	<ol style="list-style-type: none"> <li>1 frost</li> <li>2 overloaded</li> <li>3 floor is dirty</li> </ol>	<ol style="list-style-type: none"> <li>1. Thaw</li> <li>2. Remove part of the load</li> <li>3. Clean the floor once the load has been removed</li> </ol>
<b>5. floor does not move in either the loading or unloading direction; the hydraulic system is at working pressure</b>	Measure pressure at M1 Pressure = 0-10 bar	<ol style="list-style-type: none"> <li>1. Move threaded rod backwards and forwards</li> <li>2. GS02 on/off spindle does not switch</li> </ol>

<b>malfunction</b>	<b>cause</b>	<b>remedy</b>
<b>6. GS02 on/off spindle does not switch</b>	No power	<ol style="list-style-type: none"> <li>1. Check power supply</li> <li>2. Check voltage across solenoid</li> </ol>
<b>7. GS02 on/off spindle does not switch</b>	Solenoid inoperable <ol style="list-style-type: none"> <li>1. corroded contacts</li> <li>2. Solenoid defective</li> <li>3. Breach in the cable</li> </ol>	<ol style="list-style-type: none"> <li>1. Use emergency control, see Emergency control section</li> <li>2. If the loading function is not used, then swap the solenoids for GS02 and G02; note the plugs must also be swapped</li> </ol>
<b>8. floor moves in loading direction when either loading or unloading is selected</b>	Emergency control (old G02) is in the loading position, the extreme position	Use the bayonet connection to return the spindle to the middle position.
<b>9. floor moves in the loading direction when loading is selected, but does not move when unloading is selected</b>	Plugs are connected the wrong way round on the solenoids	Reverse the plugs
<b>10. floor does not move when loading is selected, but does move when unloading is selected</b>	See point 6 or point 7	See point 6 or point 7. <ol style="list-style-type: none"> <li>1. Check the flow</li> </ol>
<b>11. all three floor groups simultaneously move backwards and forwards when unloading is selected</b>	Capacity of the system is insufficient to move the load.	See point 4d <ol style="list-style-type: none"> <li>1. Thaw</li> <li>2. Remove part of the load</li> <li>3. Clean the floor once the load has been removed</li> </ol>
<b>12. all three floor groups move correctly when unloading is selected, the individual groups move slowly whereby group 2 and 3 move together</b>	Capacity of the system is insufficient to move the load.	See point 4d <ol style="list-style-type: none"> <li>1. Thaw</li> <li>2. Remove part of the load</li> <li>3. Clean the floor once the load has been removed</li> </ol>
<b>13. other malfunction</b>	-	Contact your body builder; make sure you have the system number available when you do so



## GUARANTEE CONDITIONS

The guarantee conditions, as specified in the most recent Cargo Floor general terms and conditions for supply and payment, deposited under number 1436 by the Registrar of Commerce and Manufacturing (Kamer van Koophandel en Fabrieken) in Meppel, are applicable in unabbreviated form. On request available.

A short extract of these conditions follows:

A guarantee period of 12 months (starting directly after installation) applies for all Cargo Floor system materials supplied by us. In the case of malfunction and/or manufacturing faults we are only responsible for the costless supply of replacement parts, if:

- The Cargo Floor system is installed by your trailer builder according to our installation procedures.
- Our maintenance and control procedures have been followed.
- In the case of a malfunction, the system builder, or Cargo Floor have been informed

The following components are not covered by the guarantee:

- Malfunction of equipment, or caused by equipment, which was not supplied by us.
- Malfunction caused by the use of dirty oil, or oil of the wrong type.
- Malfunction caused by overloading or injudicious use.
- Malfunction caused by repair work, which is carried out by third parties.
- Filter elements and components, which are subject to wear-and-tear.
- Defects in electrical components due to incorrect connection and/or incorrect voltage levels.

The guarantee is void if:

- The system is used for purposes, which have not been recommended by Cargo Floor.

The Cargo Floor system has not constructed correctly by your trailer builder, insofar as this has a negative influence on the operation of the system.

You can report a request for guarantee simply on our website:  
[www.cargofloor.nl/download/download\\_cf500sl.html](http://www.cargofloor.nl/download/download_cf500sl.html);

**CF3 – LP 15/160**

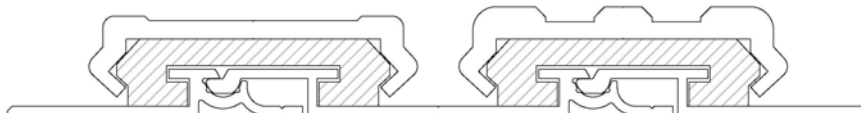
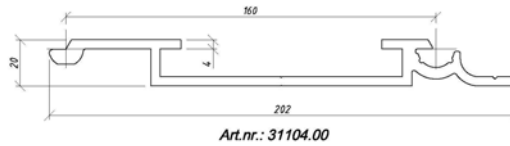
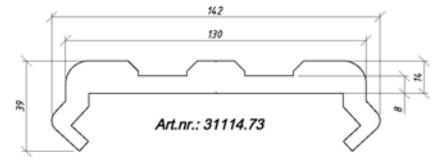
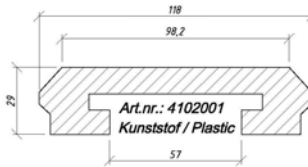
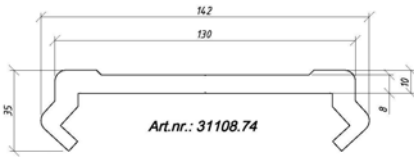
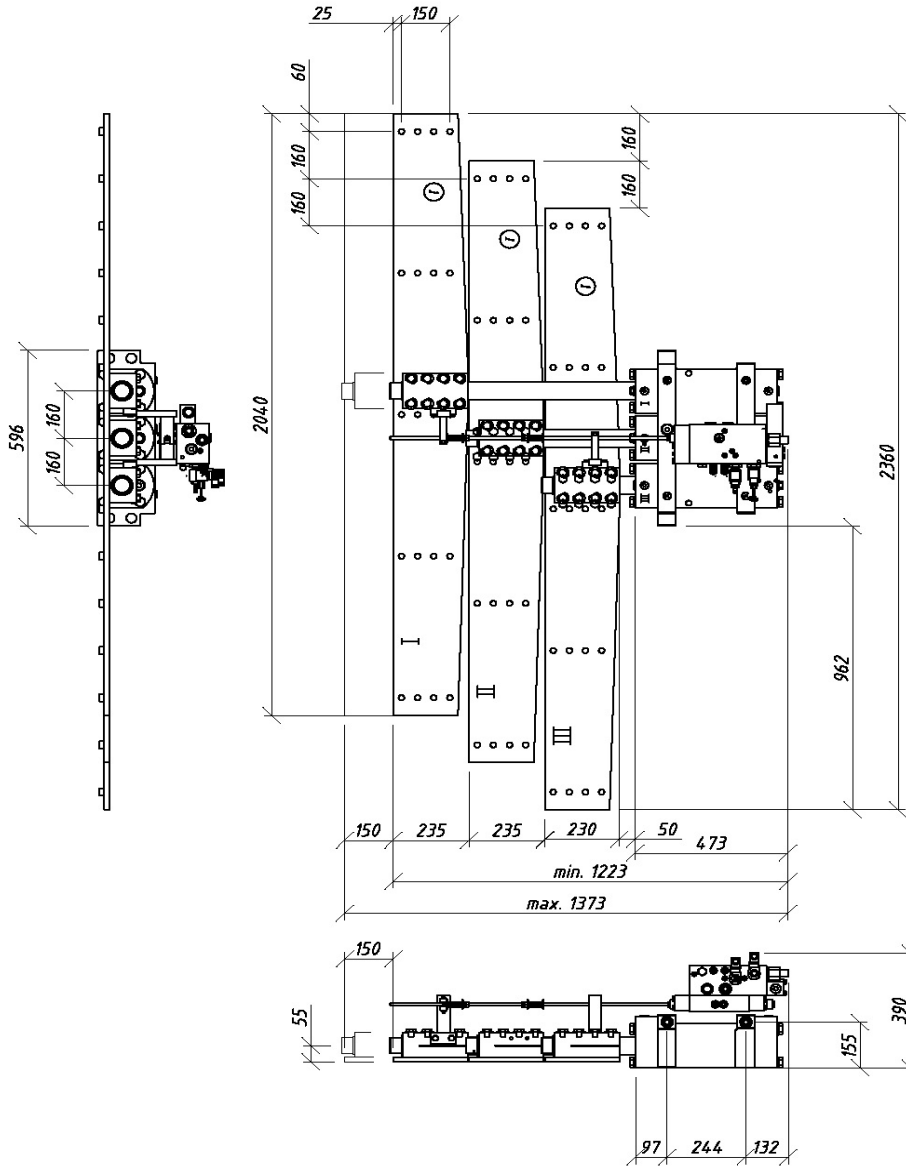

**PROFILES TYPES**

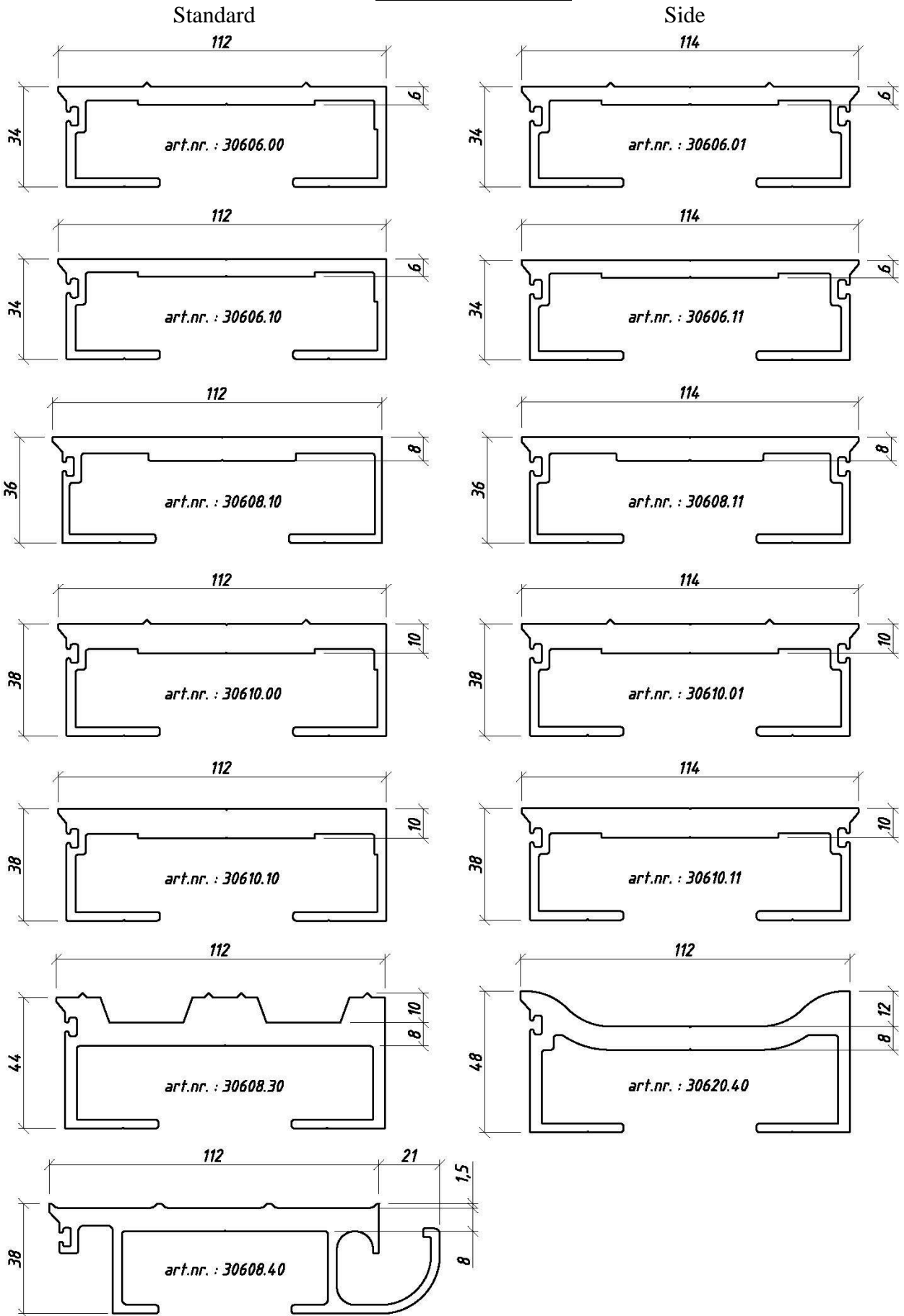

**ATTACHMENT OF FLOOR PROFILES, SEALS AND END CAPS**

