

FOR INFORMATION ONLY !

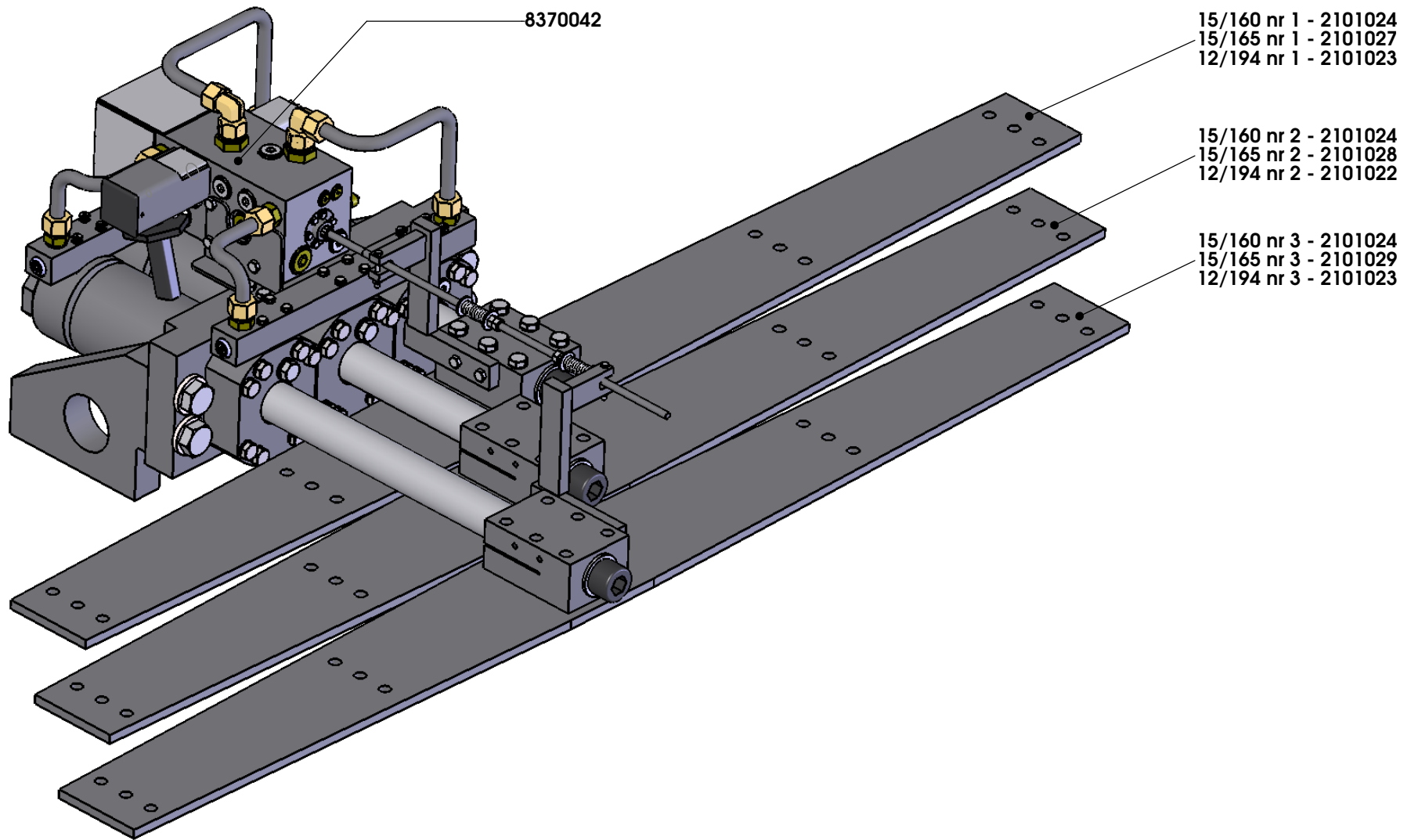

Cargo Floor B.V.
Byte 14
NL-7741 MK Coevorden
Phone : +31-524-593900
Fax : +31-524-593999
E-mail : info@cargo-floor.com

Project: **EXPLODED VIEWS CF3LP-2**

Subject: **Drive unit**

Date: 19-12-2013

Drawn: SK

Draw. nr.: **EV50002-LP-200**

A3

This drawing and the information contained herein is for general presentation purposes only.
This drawing is not intended for use on engineering plans and can be used as "as-is".
This drawing is the property of Cargo Floor B.V. and must not be copied or reproduced without their written authority.

Page 1

ART. NR. ART. NO.	AANDRIJFUNIT PAGINA 1 BENAMING	DRIVE UNIT PAGE 1 DESCRIPTION	PRIJS PRICE
2101022	Framevoet CF3LP-2 nr. 2 (12/194)	Moving crossmember CF3LP-2 no. 2 (12/194)	
2101023	Framevoet CF3LP-2 nr. 1/3 (12/194)	Moving crossmember CF3LP-2 no. 1/3 (12/194)	
2101024	Framevoet CF3LP-2 nr. 1/2/3 (15/160) verzinkt	Moving crossmember CF3LP-2 no. 1/2/3 (15/160) galvanized	
2101027	Framevoet CF3LP-2 nr. 1 (15/165)	Moving crossmember CF3LP-2 no. 1 (15/165)	
2101028	Framevoet CF3LP-2 nr. 2 (15/165)	Moving crossmember CF3LP-2 no. 2 (15/165)	
2101029	Framevoet CF3LP-2 nr. 3 (15/165)	Moving crossmember CF3LP-2 no. 3 (15/165)	
8370042	Besturingsventiel 02 B-bediend (compleet)	Control valve 02 B-operation (complete)	
<p>Prijzen: per stuk in EURO, excl. B.T.W.</p> <p>Levering: af werk, volgens onze standaard leverings- en betalingsvoorwaarden</p> <p>Betaling: netto, binnen 14 dagen na factuurdatum</p> <p>Wijzigingen voorbehouden.</p>		<p>Prices: each in EURO, excl. VAT</p> <p>Delivery: Ex Works, according to our standard terms of payment and delivery</p> <p>Payment: nett, due 14 days from date of invoice</p> <p>All changes reserved</p>	

 +31 524 593 900

 info@cargofloor.com

www.cargofloor.com

FOR INFORMATION ONLY !

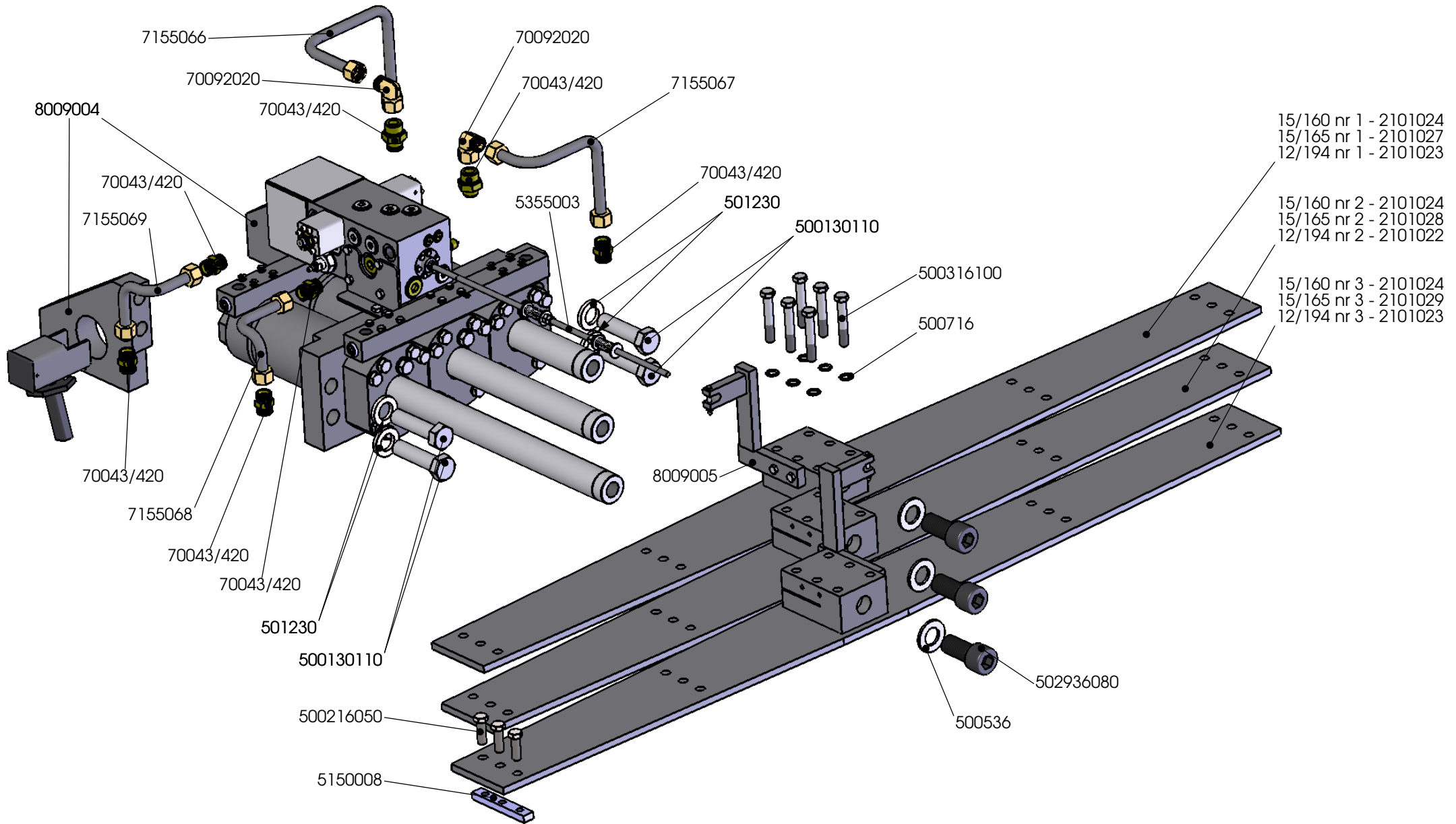

ART. NR. ART. NO.	CILINDERS, LEIDINGEN, FRAMEVOETEN EN STEUNEN PAGINA 2 BENAMING	CYLINDERS, PIPES, CROSS MEMBERS AND BRACKETS PAGE 2 DESCRIPTION	PRIJS PRICE
501230	Veerring M30 elvz	CF3-LP Spring washer M30 elvz Support	
500536	Sluistring M36 elvz (vlak)	Plain washer M36 zinc plated	
500716	Borgring M16 (Nord-lock)	Vibration proof washer M16 (Nord-lock)	
2101022	Framevoet CF3LP-2 nr. 2 (12/194)	Moving crossmember CF3LP-2 no. 2 (12/194)	
2101023	Framevoet CF3LP-2 nr. 1/3 (12/194)	Moving crossmember CF3LP-2 no. 1/3 (12/194)	
2101024	Framevoet CF3LP-2 nr. 1/2/3 (15/160) verzinkt	Moving crossmember CF3LP-2 no. 1/2/3 (15/160) galvanized	
2101027	Framevoet CF3LP-2 nr. 1 (15/165)	Moving crossmember CF3LP-2 no. 1 (15/165)	
2101028	Framevoet CF3LP-2 nr. 2 (15/165)	Moving crossmember CF3LP-2 no. 2 (15/165)	
2101029	Framevoet CF3LP-2 nr. 3 (15/165)	Moving crossmember CF3LP-2 no. 3 (15/165)	
5150008	Montagestrip CF3 LP (3 x M16 L=150 mm)	Assembly strip CF3 LP(3 x M16 L=150 mm)	
5355003	Draadstang compleet (1000 mm.)	Threaded rod complete (1000 mm. [39.4"])	
7155066	Hydraulische leiding nr. 1 (besturingsventiel 02/CF3LP-2)	Hydraulic pipe no. 1 (control valve 02/CF3LP-2)	
7155067	Hydraulische leiding nr. 2 (besturingsventiel 02/CF3LP-2)	Hydraulic pipe no. 2 (control valve 02/CF3LP-2)	
7155068	Hydraulische leiding nr. 3 (besturingsventiel 02/CF3LP-2)	Hydraulic pipe no. 3 (control valve 02/CF3LP-2)	
7155069	Hydraulische leiding nr. 4 (besturingsventiel 02/CF3LP-2)	Hydraulic pipe no. 4 (control valve 02/CF3LP-2)	
8009004	Lassteun CF3LP-2	Welding bracket CF3LP-2	
70092020	Stelbare haakse koppeling 20 x 20 mm.	Regulate square coupling 20 x 20 mm.	
500130110	Zeskantbout M30x110	Hexagonal bolt M30x110	
500216050	Zeskanttapbout M16x50 elvz	Hexagon head screw M16 x 50 zinc plated	
500316100	Zeskanttapbout M16x100 zwart (10.9)	Hexagonal machine bolt M16x100 black (10.9)	
502936080	Inbusbout M36x80	Head cap screw M36x80	
70043/420	Rechte inschroefkoppeling 3/4" x 20 mm.	Straight screw-in coupling 3/4" x 20 mm.	
	<p>Prijzen: per stuk in EURO, excl. B.T.W.</p> <p>Levering: af werk, volgens onze standaard leverings- en betalingsvoorwaarden</p> <p>Betaling: netto, binnen 14 dagen na factuurdatum</p> <p>Wijzigingen voorbehouden.</p>	<p>Prices: each in EURO, excl. VAT</p> <p>Delivery: Ex Works, according to our standard terms of payment and delivery</p> <p>Payment: nett, due 14 days from date of invoice</p> <p>All changes reserved</p>	

 +31 524 593 900

 info@cargofloor.com

www.cargofloor.com

FLOOR PROFILE

10/133 Leak Proof Deckslat HD (Heavy Duty)
 Artikelnr. : 89.3497

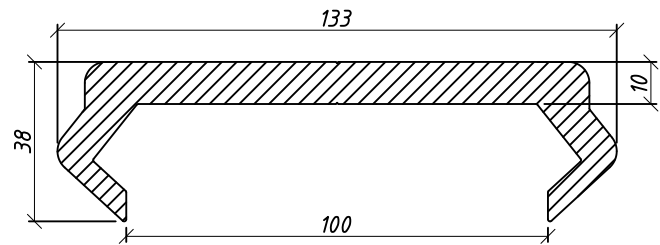

7/133 Leak Proof Deckslat Standaard
 Artikelnr. : 891.4460

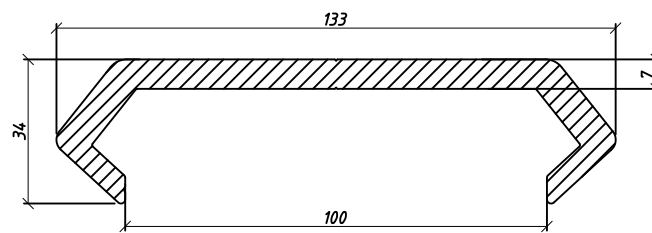

6/155 Leak Proof Deckslat smooth (refrigerated trailer)
 Artikelnr. : 84.6149

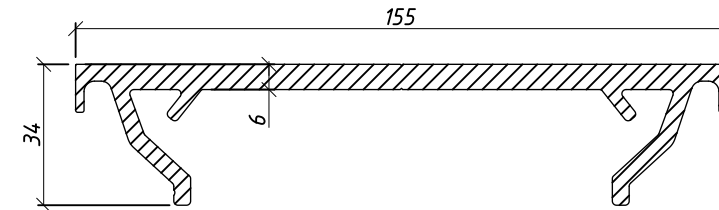

6/160 Leak Proof Deckslat SEALED
 Artikelnr. : 86.6313

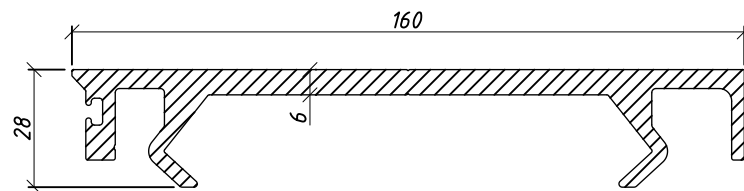

6/160 Leak Proof Gutter sealprofile
 Left L=250mm Artikelnr. : 5448011
 Right L=250mm Artikelnr. : 5448012

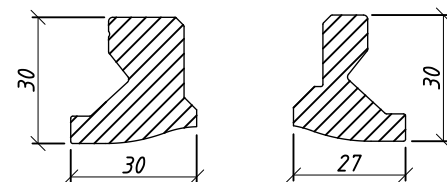

8-20/160 Leak Proof Deckslat HD-SEALED
 Artikelnr. : 862.7825

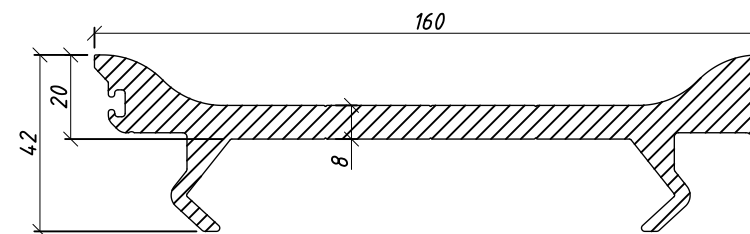

8-20/160 Leak Proof Gutter side-sealprofile
 Artikelnr. : 5448013 (L=250mm)

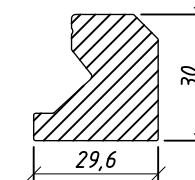

Plastic glider bearing T-subdeck LP
 Artikelnr. : 4107022.01 and 4107022.02

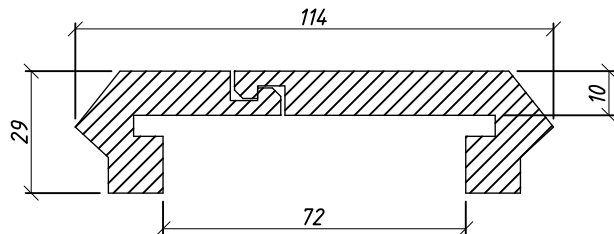

Plastic glider bearing T-subdeck LP with finger-opening
 Artikelnr. : 4107045

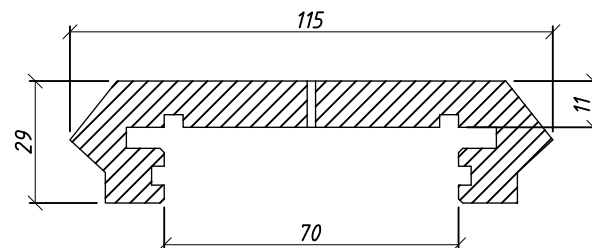

Aluminium endstop T-subdeck LP floor
 Artikelnr. : 5448006
 L=350mm

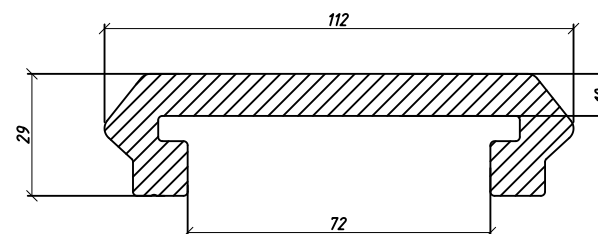

T-SUBDECK PROFILES

Alu 8/160 Leak Proof T subdeck (Slide-in)
 Artikelnr. : 871.5177

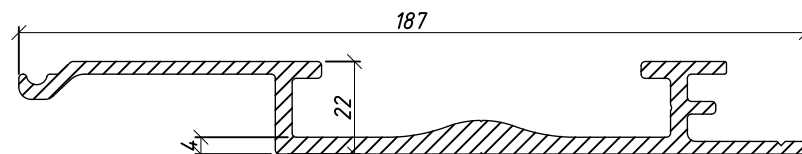

(SLIDE-IN)

Alu 8/160 Leak Proof T subdeck (Turn-in)
 Artikelnr. : 871.4327

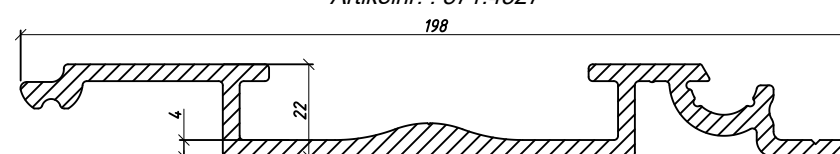

(TURN-IN)

Alu 4/160, LR/LP, T-subdeck plane gutter area (slide-in)
 Artikelnr. : 862.7827

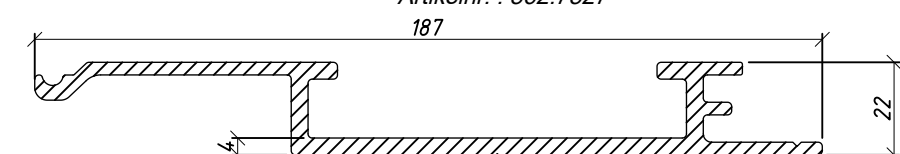

(SLIDE-IN)



Cargo Floor B.V.
 Byte 14
 NL-7741 MK Coevorden
 Phone : +31-524-593900
 E-mail : info@cargofloor.com



PROJECT:
Exploded views CF3LP
 SUBJECT:
Overview Floor

All rights strictly reserved. Reproductions or issue to third parties in any form whatever is not permitted without written authority from the proprietor.

ORDER: ---
 DATE: 20-07-06
 DRAWN: Braakman

F	25-02-19	Diverse toevoegingen	ES
E	21-02-18	T-solid glider update	ES
D	24-01-14	Art.nr + maataanduiding	SK
C	17-01-14	Arcering + tekst	MP
B	16-12-13	Profielen aanpassen	SK
A	18-08-10	Profielen aanpassen	HZ
REV	DATE	CHANGES	BY

PAGE
3
 DRAWING NUMBER :
EV3LP001-CF-223

ART. NR. ART. NO.	VLOERDELEN PAGINA 3 BENAMING	FLOOR PARTS PAGE 3 DESCRIPTION	PRIJS PRICE
84.6149	Alu profiel 6/155mm glad koeltrailer	Alu profile 6/155mm smooth for refrigerated trailer	
86.6313	Alu. vloerprofiel "deckslat", LR/LP-serie, 6/160 SEALED	Alu. floorprofile "deckslat", LR/LP-series, 6/160 SEALED	
89.3497	Alu 10/133mm Leak Proof deckslat HD(heavy duty)	Alu 10/133mm Leak Proof deckslat HD (Heavy Duty)	
4107045	Kunststof geprofileerd massief afdichtingsprofiel voor T-subdeck (locatie montagevinger), LR-series. opm. altijd per vloerprofiel 2 stuks nodig welke zijdelings in elkaar schuiven L=760mm.	Plastic profiled solid sealing profile for T-subdeck (located at mounting finger), LR-series. remark each deckslat needs 2 pcs which slide sideways into each other L=760mm.	
5448006	Aluminium eindstop T-subdeck LP vloer (350 mm)	Aluminum endstop T-subdeck LP floor (350 mm. [13.78"])	
5448011	Alu. goot afsluitprofiel links t.b.v. "deckslat" SEALED (L=250mm)	Alu. gutter stop profile right for "deckslat" SEALED (L=250 mm)	
5448012	Alu. goot afsluitprofiel rechts t.b.v. "deckslat" SEALED (L=250 mm)	Alu. gutter stop profile right for "deckslat" SEALED (L=250 mm)	
5448013	Alu zijprofiel voor LR/LP-serie, 8-20/160 mm HD sealed (L.= 250 mm)	Alu sideprofile for LR/LP-series, 8-20 160 mm HD sealed (L.= 250 mm)	
862.7825	Alu 8-20/160mm deckslat HD SEALED voor LR/LP-series	Alu 8-20/160mm deckslat HD SEALED for LR/LP-series	
862.7827	Alu LIGHTWEIGHT T-subdeck 4/160mm (slide-in) plane gutter area, alleen voor SEALED LR/LP series	Alu LIGHTWEIGHT T-subdeck 4/160mm (slide-in) plane gutter area, only for SEALED LR/LP series	
871.4327	Alu 8/160mm Leak Proof T subdeck (Turn-in)	Alu 8/160mm Leak Proof T subdeck (Turn-in)	
871.5177	Alu 8/160mm Leak Proof T subdeck (Slide-in) voor alu/staal	Alu 8/160mm Leak Proof T subdeck (Slide-in) for alu/steel	
891.4460	Alu 7/133mm Leak Proof deckslat standaard	Alu 7/133mm Leak Proof deckslat standard	
4107022.01	Kunststof geleidingsprofiel massief, ½ deel type A behorend bij deel B, LP/LR serie (Alu 133 LP,T-groef 84 mm.) l=2000 mm. Standaard	Plastic bearing strip solid, ½ part type A belonging to part B, LP/LR serie (alu 133 LP,T-groove 84 mm), l=2000 mm standard	
4107022.02	Kunststof geleidingsprofiel massief, ½ deel type B behorend bij deel A, LP/LR serie (Alu 133 LP,T-groef 84 mm.) l=2000 mm. Standaard	Plastic bearing strip solid, ½ part type B belonging with part A, LP/LR serie (alu 133 LP,T-groove 84 mm), l=2000 mm standard	
<p>Prijzen: per stuk in EURO, excl. B.T.W.</p> <p>Levering: af werk, volgens onze standaard leverings- en betalingsvoorwaarden</p> <p>Betaling: netto, binnen 14 dagen na factuurdatum</p> <p>Wijzigingen voorbehouden.</p>		<p>Prices: each in EURO, excl. VAT</p> <p>Delivery: Ex Works, according to our standard terms of payment and delivery</p> <p>Payment: nett, due 14 days from date of invoice</p> <p>All changes reserved</p>	

 +31 524 593 900

 info@cargofloor.com

www.cargofloor.com